



austyle  
architectural  
hardware  
2021



# *auSTYLE* architectural hardware

The austyle philosophy demonstrates how good ideas become reality.

Every austyle product is designed and manufactured with an emphasis on quality raw materials, practical functionality and unique designs.

Whether the product is 304, 316 stainless steel or solid virgin brass, strength in foundation through the use of high grade raw materials ensures austyle products can withstand the tolerances required in all commercial or domestic, internal or external applications.

*auSTYLE* Architectural Hardware and Builders Choice Hardware are brands of Superior Brass. Established in 1982 and starting with a traditional range of 10 lever handles, the range now extends to over 3000 products across multiple brands and multiple market segments.

Austyle products are manufactured to exceed ISO9000 international quality standards and are mechanically and practically functional as well as simple and easy to install.

Our in house design team develops products that reflect current market styles and trends and many of our unique designs have design registrations and mechanical patents to protect their individuality.

Welcome to the austyle range of quality architectural hardware and a new approach in design innovation.

## opening doors in *auSTYLE*

Head Office / Showroom  
137-145 Chesterville Rd.  
Moorabbin, Victoria 3189, Australia

Postal  
P.O.Box 623 Moorabbin,  
Victoria 3189, Australia





# myLOCK

## Practical & Multi-Functional Living.

### Integrated Latch, Privacy & Dead Bolt

Now available in both 30mm and 60mm backsets



PROJECT SERIES  
[builderschoicehardware.com.au](http://builderschoicehardware.com.au)



MODERN COMMERCIAL  
[austyle.com.au](http://austyle.com.au)



TRADITIONAL & CLASSIC  
[superiorbrass.com.au](http://superiorbrass.com.au)

# Contents - Selecting the Right Hardware

<b>Door Handles</b>	<b>18</b>	Escutcheon Covers	74
316 Stainless Steel Passage/Privacy sets	20-21	Bathroom Locking Options Sliding & Hinges	
DDA Compliant Commercial Lever Sets	23	Doors	75-76
Long Plate Entrance Sets 228mm 316		<b>Flush Pull Handles</b>	<b>78</b>
Stainless Steel - Fire Rated	24-29	Sliding Door Flush Pulls	80
Long Plate Entrance Sets 225mm		Integrated Entrance Door Flush Pull	81
Builders Choice Range	30-31	Sliding Door Edge Pulls	81
Long Plate Entrance Sets 200mm	32	<b>Kitchen/Cupboard Handles</b>	<b>82</b>
Project Series Key-in-lever sets	34	Drawer Pull Handles	84-85
<b>Feature Entry Pull Handles</b>	<b>36</b>	Knobs Pulls	86-87
Timber Options	38-39	<b>Hinges</b>	<b>88</b>
Designer Series	40-43	Commercial Fire Rated Butt Hinges	90
Integrated Flush/Pull Handle	44	Square Knuckle Butt Hinges	90
Aluminium Series	45	Broad Butt Hinges	91
Glass	46	Ball Bearing Hinges	91
Round	51	Fast Fix Hipline Ball Bearing Hinges	92
Offsets	58	Long Body Heavy Duty Hinges	92
Square	61	Radius Hinges	92
Accessories	61	Bathroom Door - Lift Off Hinges	93
<b>Security</b>	<b>62</b>	Bathroom Door - Self Closing Hinges	93
Residential myLOCK Integrated Keyless		<b>Door Bolts</b>	<b>94</b>
Snibbing Latch & Roller	64-65	Panic Bolts (Including Keepers & Accessories)	95
Residential Quad Lock – Multi Function		Barrel Bolts	97
Entrance Lock	66	Flush Bolts	97
Narrow Back-set Locks (Aluminium)	69	<b>Door Stops</b>	<b>98</b>
Roller Locks	70	Wall / Floor Mount	100
Self-Latching Security	70	Heavy Duty Door Catches	101
Cavity/Sliding Door Locks	71	Magnetic Door Catches	101
Dead Bolt	71	<b>Alphabet &amp; Numerals</b>	<b>102</b>
Security Cylinders	72	House Numerals	104
Bathroom Privacy Adaptors	72	Alphabet	105
Passage Latches	73	Bathroom Signs	105
Roller & Ball Catches	73		
Magnetic Door Catch	73		

## Family Ranging

Satin Brass Finish	8-9
Matt Black Finish	10-11
Satin Stainless Steel Finish	12-13
White & Monument Finishes	14-15
Security Family - Timber Doors	16
Security Family - Aluminium Doors	17



Door Handles /  
Passage, Privacy &  
Entrance Sets **P.18**



Feature Entrance  
Handles **P.36**



Security **P.62**



Flush Pull  
Handles **P.78**



Joinery Kitchen  
Cupboard Handles **P.82**



Hinges **P.88**



Flush, Panic, Door /  
Window Bolts **P.94**



Door Stops and  
Catches **P.98**



Numbers and  
Alphabet **P.102**

# Product Numbers

## PREFIX = FINISH

The prefix digit represent the finish color - see below

0-9

## BASE PRODUCT NUMBER

The LAST four digits represent the base item number.

XXXX

# Finishes

<b>PB</b>	[none]	Polished Brass [4 digit product number]
<b>PVD</b>	1	PVD Brass Finish - 50 year Anti-Tarnish Warranty
<b>ATQ</b>	2	Antique Finish with Copper Highlight
<b>CP/ PSS</b>	3	Chrome Plate or Polished Stainless Steel Finish
<b>SC/ SSS</b>	4	Satin Chrome or Satin Stainless Steel Finish
<b>MB</b>	5	Matt Black
<b>COP</b>	6	Polished Copper Finish
<b>ATQ BNZ</b>	7	Antique Bronze
<b>WH</b>	8WH	White
<b>MO</b>	8MO	Monument
<b>SB</b>	9	Satin Brass
●		Plated To Order

# Key Hole Punching Legend

myLOCK



## DETERMINING THE HANDING

Standing on the INSIDE and facing the door... Which way is the lever pointing?



EURO CYLINDER  
85mm C/C  
xxxxE



EURO CYLINDER  
47.6mm C/C  
xxxxA



PRIVACY  
57mm C/C  
xxxxP



SKELETON KEY  
57mm C/C  
xxxxK



## Icon References



The Ball Bearing is the invisible hero of a friction free operation. The Stainless Steel ball bearing promotes smooth mechanical operation, durability and longevity. The Ball Bearing accompanies a four hour fire rating (Australian Standard # AS1530.4-1997 and BS476.). There are no assembled plastics or nylons in the austyle lever mechanisms.



Quality is never an accident, it is the result of intention, innovation and skillful execution. When the base materials used in manufacturing are of a high standard, the end product lends itself to comprehensive long term mechanical confidence. Our products will simply work and accompany a 7 year residential warranty.



Many items in our range are manufactured using 304 or 316 stainless steel where commonly these types of products are usually manufactured by our competitors in zinc or steel. Stainless Steel offers significantly superior durability and reliability whether used as the base material of the product structure or within its mechanism.



The PVD Brass Finish offers a traditional appearance with a 50 Year Anti-Tarnish warranty against, pitting, discolouring and corrosion. If your project/client has a traditional brief/style with all the benefits of modern durable mechanical operation, this is the product for you. ([www.superiorbrass.com](http://www.superiorbrass.com))



Many austyle locks have been fire tested in Australia and have passed either 2 and 4 hours in simulated fire conditions. The rating refers to the fire test only. Installers and specifiers should verify and ensure the appropriate lock meets the appropriate operational building code or fire door requirement.



The austyle ball bearing mechanism, myLOCK and Quadlocks are patented which protects its exclusivity, individuality and uniqueness. Choosing an austyle patented product ensures you're purchasing a product designed in Australia for the Australian market.

myLOCK <sup>4</sup>QuadLock



All austyle lever handles and heavy duty passage latches have accompanying long term mechanical warranties. After correct installation, you can relax with long term confidence that our product will simply continue to operate as it did on day one.



Austyle passage sets have a unique tamper proof mechanism. When installed correctly, the external lever will not have a visible screw head under the concealing ring. This prevents the handle being tampered with and removed from the external side to gain internal access.

# Satin Brass Finish

**SB**



**93580 Linear Lever Set.**  
 >SS Ball Bearing Mechanism.  
 >ALL IN ONE - Passage & Privacy options included.  
 >63mm backplates -Ideal for retro fitting into existing doors.

93733 **Escutcheon** Cover 52mm  
 99209 **Entrance Lock** 60mm/85mm  
 99144 **Double Cylinder** 65mm (SB)



**Tapered Lever Set**  
 All In One - Passage and Privacy (pictured)  
 93585



93585 **Tapered Lever Set**  
 SS Ball Bearing Mechanism  
 ALL IN ONE - Passage & Privacy options included  
 63mm backplates -Ideal for retro fitting into existing doors



## Sliding Door Flush Pull

93749  
 Flush Pull 150x50mm.

## Sliding Door Edge Pull

94455 - 80x25mm.



## Bathroom Doors

99040  
 Recessed bathroom  
 privacy snibs 40mm diam  
 (use with 19033 latch)



## Door Stop

93080  
 Floor Mounted  
 Door Stop 45mm

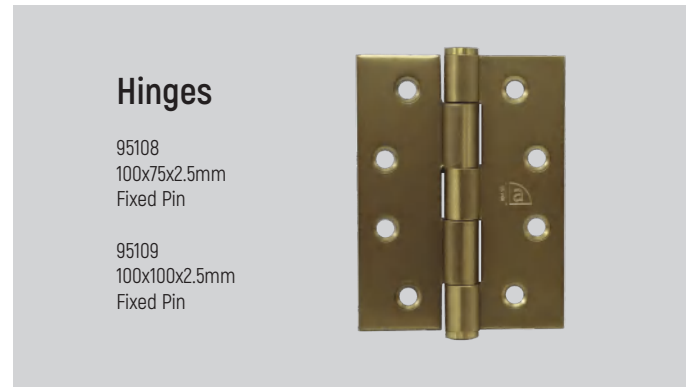

## Hinges

95108  
 100x75x2.5mm  
 Fixed Pin

95109  
 100x100x2.5mm  
 Fixed Pin



## Entrance Option

93580 Lever Handle  
 93733 Escutcheon Cover 52mm  
 99209 Entrance Lock 60mm/85mm  
 99144 Double Cylinder 65mm (SB)





**Blade Entry  
Pull Handle**

93936  
Blade Pull Handle  
450mm (40x15mm)



**Square Entry  
Pull Handle**

93995  
450mm (20x40mm)

93996  
600mm (20x40mm)

93736  
Escutcheon Snib Set  
145x40mm

19217  
myLOCK  
Entrance Roller  
Lock



**Circular Entry  
Pull Handle**

93994  
230mm Diameter  
Round Pull

93733  
Escutcheon

99144  
65mm Double Cylinder



**Tube Entry  
Pull Handle**

93866  
25mm Tube  
450mm

93868  
32mm Tube  
600mm



**Tapered  
Offset Entry  
Pull Handle**

93928  
450mm Tapered  
Offset Pull

93929  
600mm Tapered  
Offset Pull



**Cabinet  
Pull Handle**

98702  
12 x 12mm x 236mm

# Matt Black Finish

**MB**

## Entrance Family



External Doors



Front Doors  
Roller Entrance Locks / Pull Handles

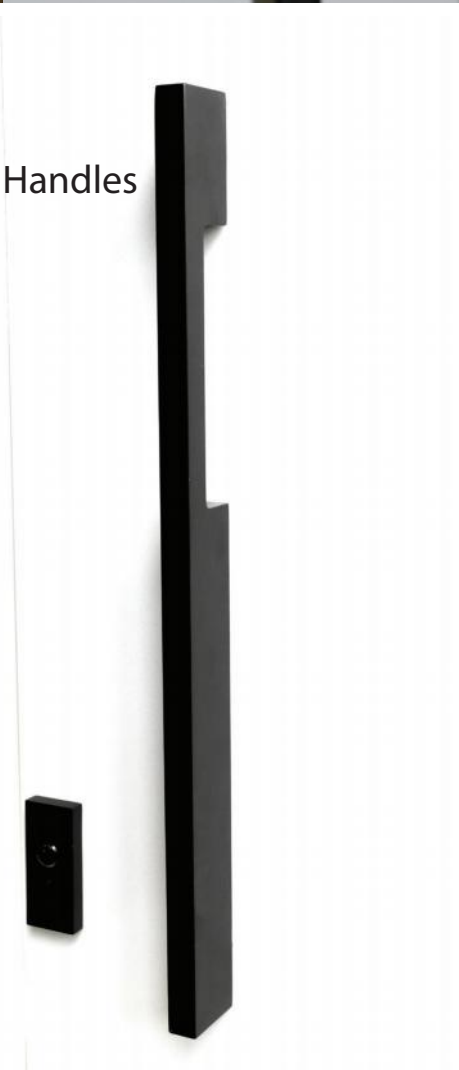

## Internal Family



Passage Privacy / Hinges / Door Stops / Cabinet Handles

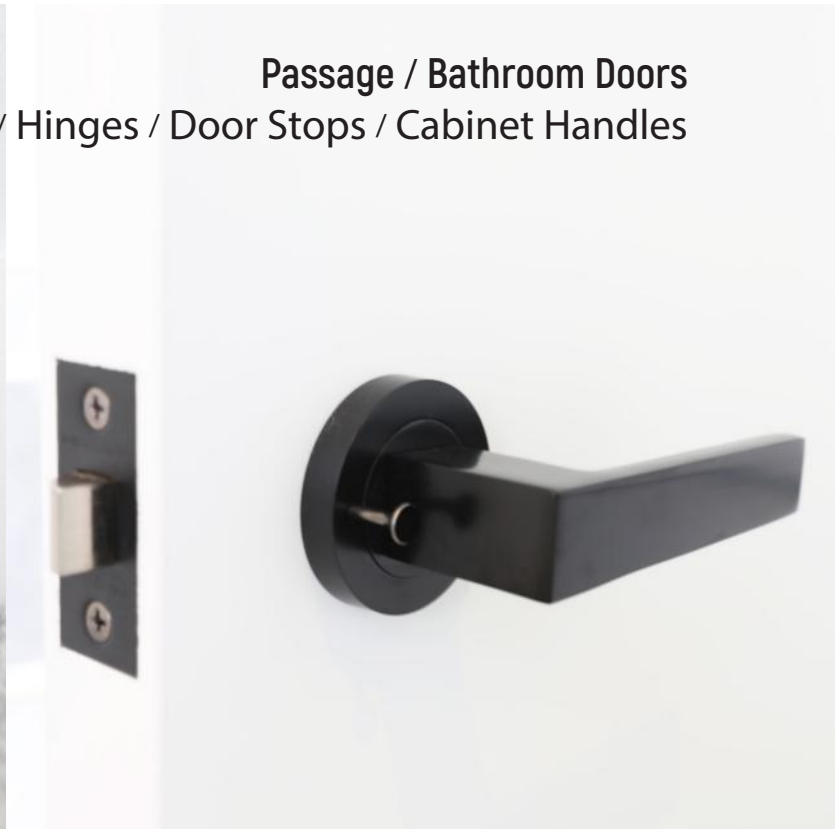

Passage / Bathroom Doors

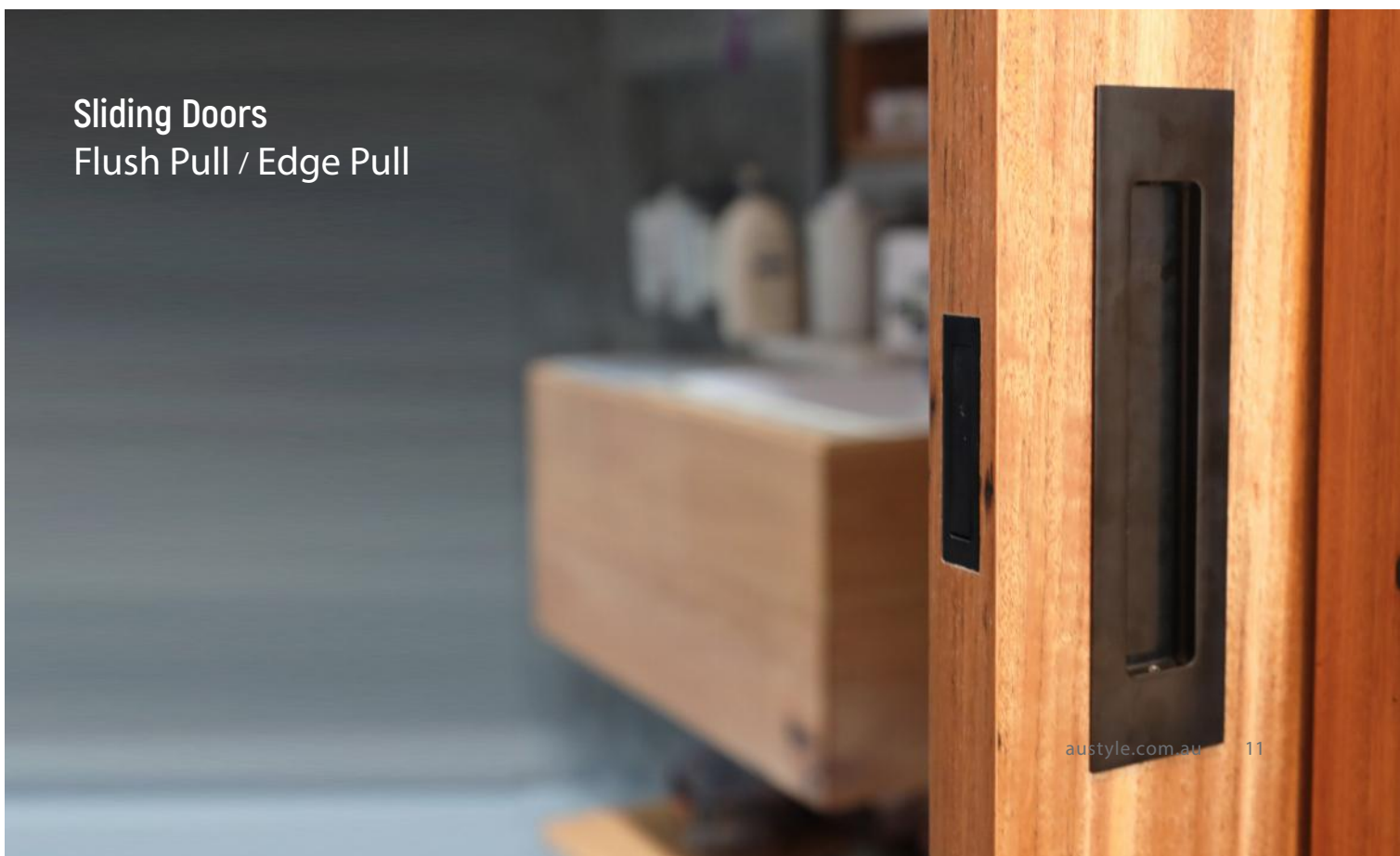

Sliding Doors  
Flush Pull / Edge Pull

# Satin Stainless Steel Finish

SSS

## Entrance Family

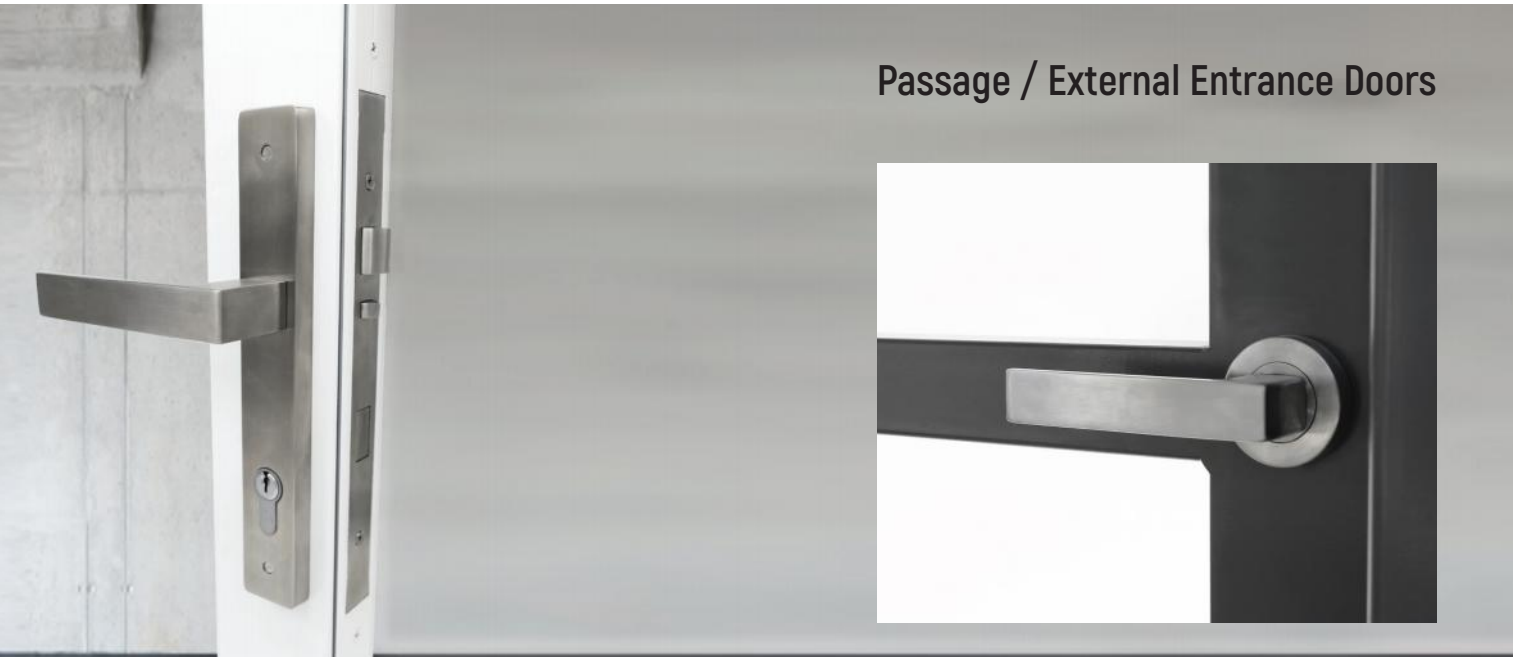

# Internal Family

Passage / Privacy Bathroom Doors / Hinges



Cavity Sliding Doors  
Flush Pull  
Door Edge Pull



# White Family

**WH**

Plated To Order



83540WH (52mm Rose)  
Lever Handle



83724WH  
Rectangle  
Escutcheon

89144WH  
65mm Cylinder



83830WH  
Offset Entry  
Pull Handle  
600mm

83724WH  
Rectangle  
Escutcheon

89144WH  
65mm Cylinder



83749WH  
Flush Pull  
150x50mm



83936WH  
Blade Pull  
Handle  
450mm



85118WH  
Loose Pin Fire Rated Hinge  
100x75x2.5mm



83868WH  
Entry Pull  
Handle  
600mm

# Monument Family

**M0**

Plated To Order



83580M0 (63mm Rose)  
Lever Handle



83936M0  
Blade Pull Handle  
450mm



83888M0 Pull Entry Handle 500mm  
83724M0 Rectangle Escutcheon  
89144M0 Double Cylinder 65mm



85108M0  
Hinge  
100x75mm

# Security Family - Timber doors



304  
STAINLESS STEEL



DURABLE  
SECURITY



INTEGRATED  
PRIVACY OPTION



INTEGRATED  
KEYLESS SNIB LOCK



INDEPENDENT  
CAM OPERATION



myLOCK  
QuadLock

## myLOCK Entrance Roller

### myLOCK

Integrated Roller  
Privacy & Dead bolt functionality  
Front Adjustable Roller Tension  
60mm Backset / 83mm Overall

- 19217 **PVD**
  - 29217 **ATO**
  - 39217 **PSS**
  - 49217 **SSS**
  - 59217 **MB**
  - 69217 **COP**
- See Page 64/65  
for all Features  
& benefits

Rebate Kit Available x9220



## myLOCK Entrance

### myLOCK

Integrated Roller  
Privacy & Dead bolt functionality  
85mm C/C / 36mm Privacy C/C  
60mm Backset / 83mm Overall

- 19219 **PVD**
  - 29219 **ATO**
  - 39219 **PSS**
  - 49219 **SSS**
  - 59219 **MB**
- See Page 64/65  
for all Features  
& benefits

Rebate Kit Available x9220



## Dead Latch Escape

Emergency Escape Function  
Dead Latching Trigger  
Ideal for All Fire Doors  
60mm Backset / 83mm Overall

- 49301 **SSS**
- 59301 **MB**



## Multi-Function Entrance Lock

### 4 QuadLock

4 Modes Of Operation  
Emergency Escape Option  
Dead Latching Mode Option  
Dead Bolt Mode Option  
Latching Mode Option

Ideal for All Escape / Fire Doors  
60mm Backset / 83mm Overall

- 19300 **PVD**
  - 29300 **ATO**
  - 39300 **PSS**
  - 49300 **SSS**
  - 59300 **MB**
- See Page 66/67  
for all Features  
& benefits

Rebate Kit Available x9304



## Entrance Sliding Door

Elongated Striker Plate Holes  
Allows For Movement Of The  
Door  
2 Locating Pins Guide The Door  
Into correct Position When  
Closing  
45mm Backset / 62mm Overall

- 9086 **PVD**
- 29086 **ATO**
- 39086 **PSS**
- 49086 **SSS**
- 59086 **MB**



Entrance Lock  
with full escape  
function



Entrance Lock  
without escape  
function

4



Entrance Latch  
Function  
Fire Door Exit Compliance  
Electric Strike Compatible



Latching  
Function



# Security Family - Aluminium doors



304  
STAINLESS STEEL



DURABLE  
SECURITY



INTEGRATED  
PRIVACY OPTION



INTEGRATED  
KEYLESS SNIB LOCK



INDEPENDENT  
CAM OPERATION



myLOCK  
Quadlock



Metal Frame  
Flush Fix  
Installation Tabs  
Refer page 69



## myLOCK Entrance Roller



Integrated Roller  
Privacy & Dead bolt functionality  
Front Adjustable Roller Tension  
30mm Backset / 47mm Overall

49214 SSS See Page 64/65  
59214 MB for all Features  
& benefits

Rebate Kit Available x9220



## Multi-Function Entrance Lock



Multi Function entrance Lock  
4 Modes Of Operation  
30mm Backset / 47mm Overall

49311 SSS See Page 66/67  
59311 MB for all Features  
& benefits

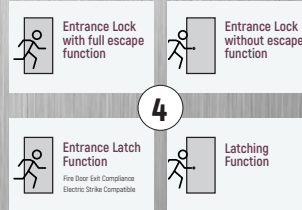

## myLOCK Entrance Sliding



Integrated Sliding Door  
Privacy & Dead bolt functionality  
30mm Backset / 47mm Overall

49285 SSS See Page 64/65  
59285 MB for all Features  
& benefits



## Entrance Roller Lock

Roller Latching Function  
Front Adjustable Roller Tension  
30mm Backset / 47mm Overall

49204 SSS  
59204 MB

Rebate Kit Available x9220



## myLOCK Entrance



Integrated Roller  
Privacy & Dead bolt functionality  
85mm C/C / 36mm Privacy C/C  
30mm Backset / 47mm Overall

19211 PV2  
39211 PSS See Page 64/65  
49211 SSS for all Features  
59211 MB & benefits

Rebate Kit Available x9220



## Entrance Lever Lock

Lever Latching Function with  
retractable latch by cylinder  
85mm C/C  
30mm Backset / 47mm Overall

49201 SSS  
59201 MB

25mm Backset

49200 SSS

Rebate Kit Available x9210

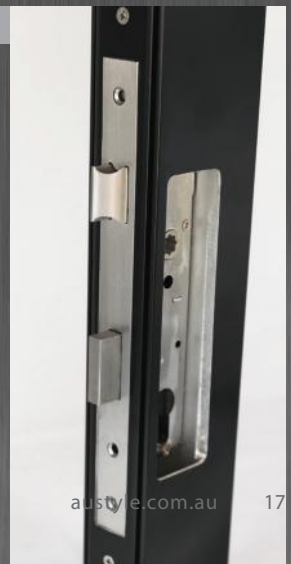



# Door Handles, Passage, Privacy & Entrance Sets



MECHANICAL  
WARRANTY



316  
STAINLESS STEEL



# Lever Handles



MECHANICAL WARRANTY



FIRE RATING



316 STAINLESS STEEL



504 SS BALL BEARING RACE MECHANISM



PATENTED MECHANISM



DDA COMPLIANT 42300

To Order **MB**

Material:  
P.20 - 316 Stainless Steel  
P.21 - Forged Solid Brass

Reference:  
 All In One Includes Integrated Privacy Option

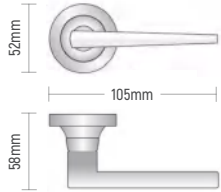

42329 - Passage  
42329P - Privacy



## Square Adaptor Plates

Use the square adaptor plate to convert the round back plate to a square design on any lever of your choice.



42309

SSS



42318

SSS



42310

SSS



42325

SSS



42320

SSS



42314

SSS



42304

SSS



42300



DDA COMPLIANT SSS



PVD   CP   SC   ORDER MB  
 13510   33510   43510   53510



33539 CP  
 43659 SC  
 53539 ORDER MB

## Square Adaptor Plates



PVD   CP   SC   ORDER MB  
 13511   33511   43511   53511



PVD   CP   SC   ORDER MB   CPD  
 13518   33518   43518   53518   63518



PVD   CP   SC   ORDER MB  
 13516   33516   43516   53516



PVD   CP   316 SSS   ORDER MB  
 13514   33514   42314   52314



PVD   CP   SC   MB  
 13520   33520   43520   53520



PVD   CP   316 SSS   ORDER MB  
 13509   33509   42309   52309



CP   SC   ORDER MB  
 33512   43512   53512



PVD  
 13519

# Accessories



Passage Door Latch

PB ATQ CP SC MB COP  
 60mm Back Set 9031 29031 39031 49031 59031 69031  
 45mm Back Set 9028 29028 39028 49028 59028



49024 SC

Magnetic Passage Door Latch  
50mm backset



9822

Dummy Fixing Spindle  
for single side fixing installation



9821

Spare Spindle Screws Kit  
2 x Sprung spindles  
2 x Tie Bolt Fixing screws  
1 set with concealed head

## Backing Cover Plates

Sit behind back plate and covers pre drilled holes in the door (63mm)



Round Plate

PVD CP SC MB  
 19816 39816 49816 59816

Square Plate

SC MB  
 49818 59818

## Adaptor Cover Plates

Multipurpose "Slip Over" auSTYLE passage sets to cover pre-existing holes in the door.



M myLock p.65  
A 47.6mm euro cyl  
hole p.68

SC MB  
 43566 53566

E 85mm euro cyl hole p68  
L Oval cyl

## THE AUSTYLE DIFFERENCE IS AS SIMPLE AS 1 - 2 - 3

**1**  
—

The Ball Bearing mechanism is the invisible hero of a friction free operation.

**2**  
—

The Stainless Steel ball bearing mechanism promotes smooth mechanical operation, durability and longevity.

**3**  
—

The Ball Bearing mechanism accompanies a four hour fire rating (Australian Standard # AS1530.4-1997 and BS476.)

Contact one of our distributors to touch and feel the auSTYLE lever handle difference in store.



# DDA Compliant Lever Handles



## DDA Compliant

For buildings used for the provision of a service or employment, the Disability Discrimination Act 2005 (DDA) gives disabled people important rights of access to everyday services.

Concealed screw head for tamper proof, high security fixing.



**SC**  
42330 Passage Set  
42330E Entrance Set



**MB**  
52330 Passage Set  
52330E Entrance Set



**SC**  
43665 Passage Set  
43665E Entrance Set



**MB**  
53665 Passage Set  
53665E Entrance Set



**316 SSS**  
42300 Lever Passage Set



**MB**  
53560 Lever Passage Set



**SC**  
43555 Lever Passage Set



**MB**  
53555 Lever Passage Set



42300+42329 Lever Passage Set with Square Plate **316 SSS**



53560+53539 Lever Passage Set with Square Plate **MB**



43555+43539 Lever Passage Set with Square Plate **SC**



53555+53539 Lever Passage Set with Square Plate **MB**

# Entrance and Passage



MECHANICAL WARRANTY



FIRE RATING



316 STAINLESS STEEL



504 SS BALL BEARING RACE MECHANISM



PATENTED MECHANISM



INTEGRATED PRIVACY OPTION

To Order  
**MB**

Material:  
316 Marine Grade Stainless Steel

Long Plates:  
228x32mm  
58mm Projection  
Concealed Screw Head For  
Tamper Proof Fixing

Passage Sets  
52mm Diam/Square

Options:  
Passage  
Entrance  
Inverted Lever  
myLOCK

Reference:  
E Entrance  
85mm Locks  
L Reversed Lever  
M myLOCK   
Specify LH/RH  
P Privacy  
Bathroom Lock

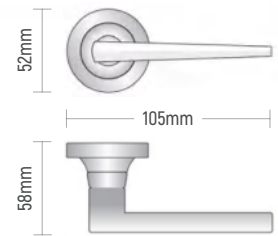
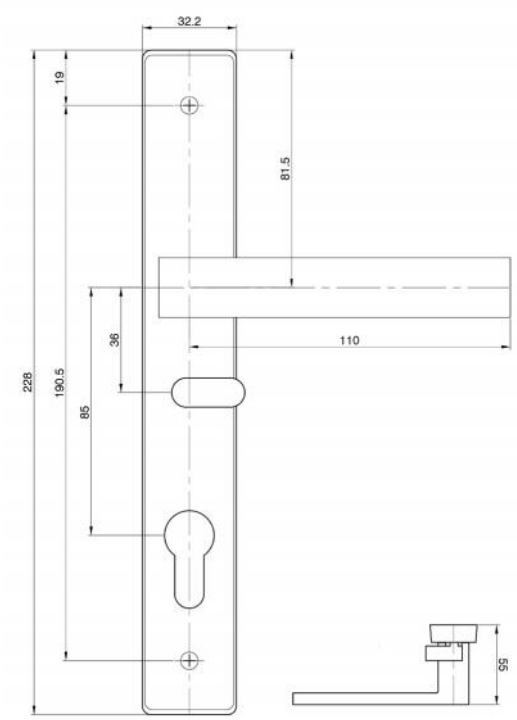

## ENTRANCE & PASSAGE EXPLAINED

**E** - Entrance Sets can be used with all high security entrance locks @ 85mm centres. Refer security section.

**L** - Reversed lever set up.

**M** - Entrance Set can be used conjunction with myLOCK high security entrance locks. Refer security section. For myLOCK entrance sets - please specify LH/RH handing. HANDING > the INTERNAL side (where the snib sits) needs to be specified and denoted as "LH or RH".



### DETERMINING THE HANDING

Standing on the INSIDE and facing the door... Which way is the lever pointing?

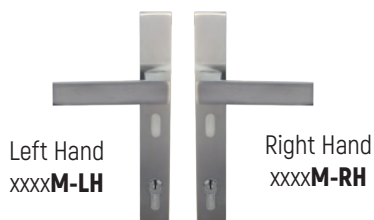

EURO CYLINDER  
85mm C/C  
XXXXE



PRIVACY  
57mm C/C  
XXXXP



BASE PRODUCT NUMBER + PUNCHING LETTER = CORRECT ITEM #





316  
SSS

Passage 42340  
Entrance 42340E  
Privacy 42340P  
Reversed 42340L  
myLOCK® 42340M



316  
SSS

Passage 42355  
Entrance 42355E  
Privacy 42355P  
Reversed 42355L  
myLOCK® 42355M



42310  
Lever Passage Set / Privacy Option

316  
SSS



42325  
Lever Passage Set / Privacy Option

316  
SSS



Passage Set: 42310 + 42329  
Privacy Set: 42310 + 42329P

42329  
Square Adaptor Plate

316  
SSS



Passage Set: 42325 + 42329  
Privacy Set: 42325 + 42329P

42329  
Square Adaptor Plate

316  
SSS

# Entrance and Passage



MECHANICAL WARRANTY



FIRE RATING



316 STAINLESS STEEL



504 SS BALL BEARING RACE MECHANISM



PATENTED MECHANISM



INTEGRATED PRIVACY OPTION

To Order

**MB**

Material:

316 Marine Grade Stainless Steel

Long Plates:

228x32mm

58mm Projection

Concealed Screw Head For

Tamper Proof Fixing

Passage Sets:

52mm Diam/Square

Options:

Passage

Entrance

Inverted Lever

myLOCK

Reference:

E Entrance  
85mm Locks

L Reversed Lever

M myLOCK   
Specify LH/RH

P Privacy  
Bathroom Lock



316

SSS

Passage 42350  
Entrance 42350E  
Privacy 42350P  
Reversed 42350L  
myLOCK 42350M

myLOCK

## DETERMINING THE HANDING

Standing on the INSIDE and facing the door... Which way is the lever pointing?



Left Hand  
xxxx**M-LH**

Right Hand  
xxxx**M-RH**



42320

Lever Passage Set / Privacy Option

316

SSS



42329

Square Adaptor Plate

Passage Set:  
42320 + 42329

Privacy Set:  
42320 + 42329P

316

SSS

EURO CYLINDER  
85mm C/C

xxxx**E**



PRIVACY  
57mm C/C

xxxx**P**





42314  
Lever Passage Set / Privacy Option

316  
SSS



43658  
Lever Passage Set / Privacy Option

316  
SSS



Passage Set:	Privacy Set:
42314 + 42329	42314 + 42329P

42329  
Square Adaptor Plate

316  
SSS



Passage Set:	Privacy Set:
43658 + 43659	43658 + 43659P

43659  
Square Adaptor Plate

316  
SSS

# Entrance and Passage



MECHANICAL WARRANTY



FIRE RATING



316 STAINLESS STEEL



504 SS BALL BEARING RACE MECHANISM



PATENTED MECHANISM



INTEGRATED PRIVACY OPTION

To Order

**MB**

**Material:**

316 Marine Grade Stainless Steel

**Long Plates:**

228x32.2mm

58mm Projection

Concealed Screw Head For

Tamper Proof Fixing

**Passage Sets:**

52mm Round/Square

**Options::**

E Entrance  
85mm Locks

L Reversed Lever

M myLOCK®  
Specify LH/RH

P Privacy  
Bathroom Lock



316 SSS  
Passage 42334  
Entrance 42334E  
Privacy 42334P  
Reversed 42334L  
myLOCK® 42334M

**myLOCK**

**DETERMINING THE HANDING**

Standing on the INSIDE and facing the door... Which way is the lever pointing?



**EURO CYLINDER**  
85mm C/C

xxxx**E**



**PRIVACY**  
57mm C/C

xxxx**P**



42304  
Lever Passage Set / Privacy Option

316 SSS



42329  
Square Adaptor Plate

Passage Set: 42304 + 42329  
Privacy Set: 42304 + 42329P

316 SSS



## DDA Compliant

42330 & 42300

For buildings used for the provision of a service or employment, the Disability Discrimination Act 2005 (DDA) gives disabled people important rights of access to everyday services.



Passage	42330
Entrance	42330E
Privacy	42330P
Reversed	42330L
myLOCK®	42330M

## Passage Door Latch



SSS

"T" Striker: 60mm Latch 49017 / 45mm Backset 49028

"D" Striker: 60mm Latch 49031



All 52mm ROUND lever sets already come with a multi-function "T" striker latch which can be used for either passage or privacy door applications. (including all components).

316 SS

## Escutcheon Cylinder Covers

Concealed Fixing. Sold cast 316SS. 52mm diameter.

316 SSS 43704 (refer P72 & 74 for cylinder and escutcheon cover options sold separately)



42300  
Lever Passage Set / Privacy Option



316 SSS



42329  
Square Adaptor Plate

Passage Set:	Privacy Set:
42300 + 42329	42300 + 42329P

316 SSS

## Integrated Privacy Kits



SSS

49016 - Privacy Latch Only (ea)

49016P - Privacy Round Covers Only (pair)



SSS

49016 - Privacy Latch Only (ea)

49072P - Privacy Square Covers Only (pair)



All 52mm ROUND lever sets already come with a multi-function latch which can be used for either passage or privacy door applications. (including all components).

# Entrance and Passage Sets



[www.builderschoicehardware.com.au](http://www.builderschoicehardware.com.au)

**Material:**  
Zinc

**Long Plates:**  
225x32mm  
55mm Projection  
Concealed Screw Head For  
Tamper Proof Fixing

**Passage Sets:**  
52mm Round  
52x52mm Square

**Options:**  
Passage  
Entrance  
myLOCK®  
Privacy/Bathroom  
Skeleton Ket

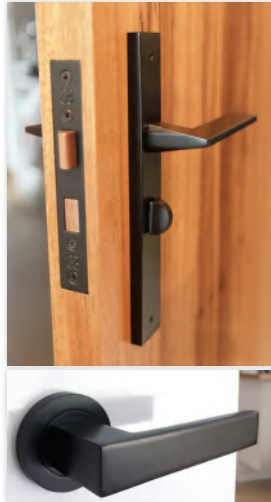

**EURO CYLINDER**  
85mm C/C



**EURO CYLINDER**  
47.6mm C/C



**SKELETON KEY**  
57mm C/C



**PRIVACY**  
57mm C/C



**myLOCK**

**DETERMINING THE HANDING**

Standing on the **INSIDE** and facing the door... Which way is the lever pointing?

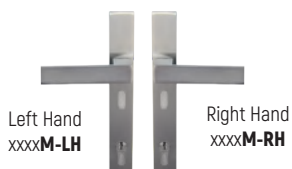

**All In One:**  
Includes both passage and privacy options all in the one box



**SC**  
43540



**MB**  
53540



**SC**  
43570





**MB**  
53570



	SC	MB
Passage	43675	53675
Entrance	43675E	53675E
Privacy	43675P	53675P
Skeleton Key	43675K	53675K
myLOCK 	43675M	53675M



	SC
Passage	43671
Entrance	43671E
Privacy	43671P
Skeleton Key	43671K
myLOCK 	43671M

 **All In One:**  
Includes both passage and privacy options all in the one box



 SC  
43545



 MB  
53545

SC  
Square Passage Set:  
43545 + 43539  
Square Privacy Set:  
43545 + 43539P + 49016

43539  
Square Adaptor Plate



 MB  
53575

 **All In One:**  
Includes both passage and privacy options all in the one box



 SC  
43541

SC  
Square Passage Set:  
43515 + 43539  
Square Privacy Set:  
43541 + 43539P + 49016

43539  
Square Adaptor Plate



Visit [www.builderschoicehardware.com.au](http://www.builderschoicehardware.com.au)  
to see the full range of levers available.

**Quality. Value. Style.**

# Entrance Sets



504 SS BALL BEARING RACE MECHANISM



FIRE RATING



LONG TERM CONFIDENCE



TAMPER PROOF MECHANISM



PATENTED MECHANISM

To Order  
**MB**

Material:  
Forged Brass

Long Plates:  
200x32mm  
55mm Projection

Passage Sets:  
52mm Round

Options:  
Passage  
Entrance  
Privacy  
Skeleton Key  
myLOCK ®



EURO CYLINDER  
85mm C/C

xxxxE



	SC	ORDER MB
Passage	43614	53614
Entrance	43614E	53614E
Privacy	43614P	53614P
Skeleton Key	43614K	53614K
myLOCK ®	43614M	53614M

	SC	ORDER MB
Passage	43610	53610
Entrance	43610E	53610E
Privacy	43610P	53610P
Skeleton Key	43610K	53610K
myLOCK ®	43610M	53610M

EURO CYLINDER  
47.6mm C/C

xxxxA



316  
SSS  
42314  
Lever Passage Set

316  
SSS  
42320  
Lever Passage Set



All In One:  
Includes both passage and privacy options all in the one box



All In One:  
Includes both passage and privacy options all in the one box

PRIVACY  
57mm C/C

xxxxP



SKELETON KEY  
57mm C/C

xxxxK



myLOCK

DETERMINING THE HANDING

Standing on the INSIDE and facing the door... Which way is the lever pointing?

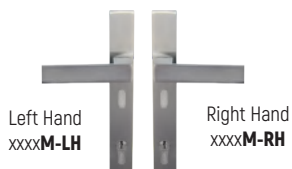

Left Hand  
xxxxM-LH

Right Hand  
xxxxM-RH





	SC	ORDER MB
Passage	43611	53611
Entrance	43611E	53611E
Privacy	43611P	53611P
Skeleton Key	43611K	53611K
myLOCK®	43611M	53611M



	SC	ORDER MB
Passage	43618	53618
Entrance	43618E	53618E
Privacy	43618P	53618P
Skeleton Key	43618K	53618K
myLOCK®	43618M	53618M



SC  
43511  
Lever Passage Set



**All In One:**  
Includes both passage and privacy options all in the one box



316  
SSS  
42318  
Lever Passage Set



**All In One:**  
Includes both passage and privacy options all in the one box

# Minimal Lever Range



MECHANICAL WARRANTY



304 SS BALL BEARING RACE MECHANISM



FIRE RATING



TAMPER PROOF MECHANISM



PATENTED MECHANISM

To Order

**MB**

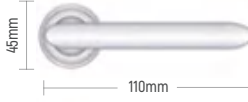
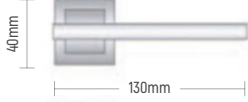

\*Indicative specifications



SC 43578 Passage Set



SC 43576 Passage Set



SC 43577 Passage Set



SC 43600 Passage Set  
CP 33600 Passage Set



SC 43603 Passage Set



SC 43605 Passage Set  
CP 33605 Passage Set

Looking for a classical traditionally reproduced handle without compromising on security?



[www.traditionalhardware.com.au](http://www.traditionalhardware.com.au)

## PROJECT SERIES RANGE

Ideal for all residential projects

Adjustable 60/70mm backset latch

C4 Cylinder profile to Australian standards

64x64mm Backplates

55mm Projection



43561E Entrance Lock Set SC



43561P Bathroom Privacy Set SC



43561 Passage Set SC



43562 Single Dummy (fixed) SC



49252 Dead Bolt Double Cylinder Entrance SC



49253 Dead Bolt Single Cylinder/Turn Snib SC

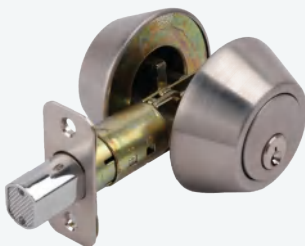

49250 Dead Bolt Double Cylinder Entrance SC

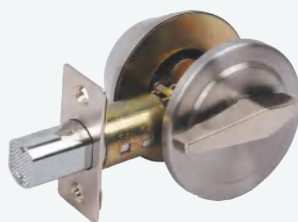

49251 Dead Bolt Single Cylinder/Turn Snib SC



Visit [www.builderschoicehardware.com.au](http://www.builderschoicehardware.com.au) to see the full range of levers available.

Quality. Value. Style.



# Feature Entrance Handles

# Timber Entrance Handles



3950  
Pair back-to-back  
Timber Grain / Satin SS legs

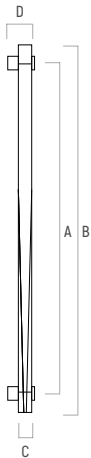

- A 1000mm
- B 1100mm
- C 43mm
- D 116mm

Fixing Screws: M8  
Fitting Holes: 10mm diameter

43862  
Pair back-to-back  
Solid Oak

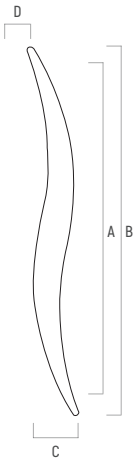

- A 400mm
- B 800mm
- C 60mm
- D 81mm

Fixing Screws: M8  
Fitting Holes: 10mm diameter



3946 - 600mm | 3948 - 900mm  
Pair back-to-back  
Blackbutt Hardwood

3942 - 300mm | 3944 - 600mm  
Pair back-to-back  
Blackbutt Hardwood



- A 400/600mm
- B 600/900mm
- C 42x32mm
- D 67mm

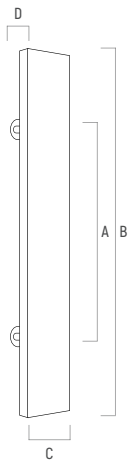

- A 100/400mm
- B 300/600mm
- C 135x32mm
- D 67mm



3944 - 600mm

Black butt hardwood timber handles are supplied as raw unfinished timber allowing you the option to stain, varnish or clear coat the timber to achieve and compliment your desired styling theme.

# Iron Entrance Handles



Hand Crafted



**MB**  
53958  
Pair back-to-back  
Rustic - Black Textured



- A 612mm
- B 660mm
- C 8x40mm
- D 80mm Projection

Fixing Screws: M8  
FittingHoles:10mmdiameter



**MB**  
53956  
Pair back-to-back  
Rustic - Black Textured



- A 515mm
- B 710mm
- C 30mm
- D 90mm Projection

Fixing Screws: M8  
FittingHoles:10mmdiameter





59217 myLOCK® Roller Entrance Lock  
 53736 Escutcheon Snib Cover  
 59144 Double Cylinder 65mm



73726 40x40mm Escutcheon Cover  
 29144 Double Cylinder 65mm



<b>MB</b>	<b>ATQ</b>
<b>BNZ</b>	<b>BNZ</b>
53955	73955
Single Side	Single Side

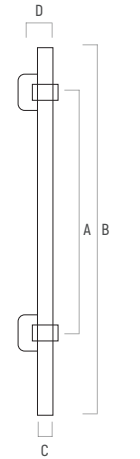

A 245mm  
 B 400mm  
 C 32x32mm  
 D 65mm



Off-Set Single Handle

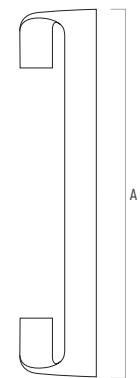

A 300mm  
 B Width 26  
 C Offset 56mm  
 D Projection 54mm

<b>PB</b>	3953
<b>ATQ</b>	23953
<b>PSS</b>	33953
<b>SSS</b>	43953
<b>MB</b>	53953

# Solid Cast 304 Entrance Handles

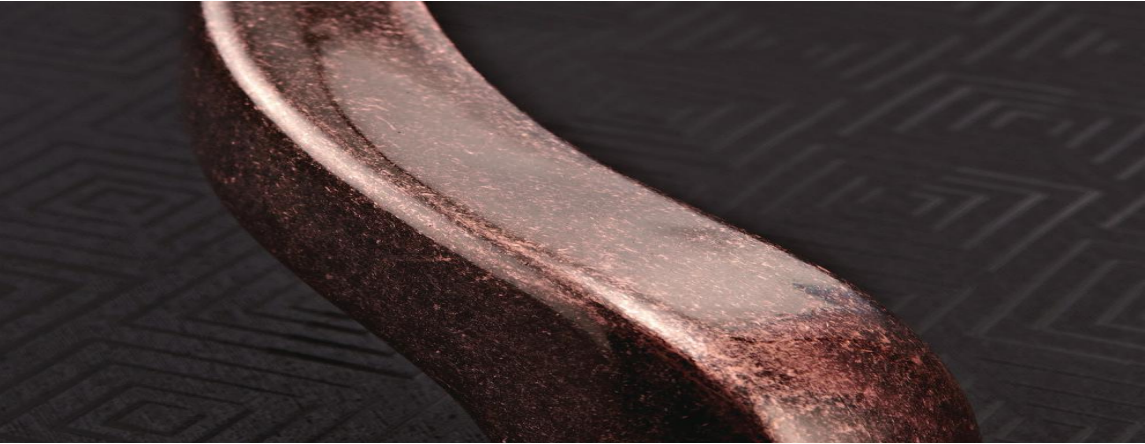



Pair back-to-back

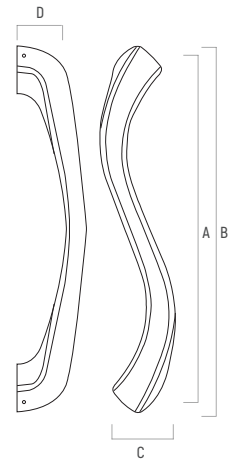

- A 350mm
- B 400mm
- C 24 x Offset 84mm
- D 82mm

Fixing Screws: M8  
Fitting Holes: 10mm diameter

Manufactured by Solid Investment Casting

304 Stainless Steel

Each pair weights 6kgs



304  
STAINLESS STEEL

- PSS 33954
- MB 53954
- CDP 63954

To Order

WH

To Order

MD



316  
STAINLESS STEEL



MECHANICAL  
WARRANTY

# Sliding Door Integrated Square Pull Handle & Flush Pull Set

304  
SSS  
43837

MB  
53837

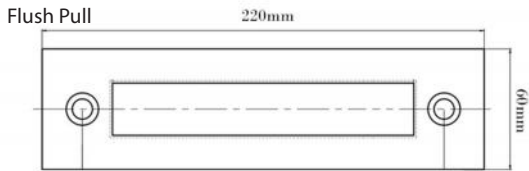
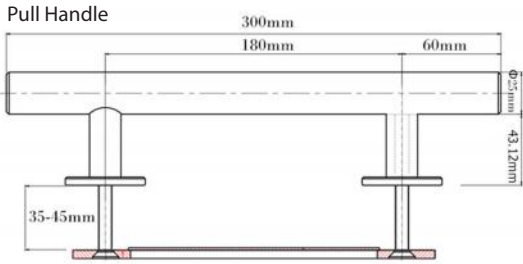



316  
STAINLESS STEEL



To Order WH	To Order MO	To Order MB	COP	PSS	316 SSS		A	B	C	D
		53885			43885	Single	300	275	25x50	65
		53886		33886	43886	Pairback-to-back	300	275	25x50	65
		53887		33887	43887	Single	500	475	25x50	65
		53888	63888	33888	43888	Pairback-to-back	500	475	25x50	65
		53890			43890	Pairback-to-back	800	775	25x50	65
		53890C			43890C	Pairback-to-back	1800	1775	25x50	65

53888 Entry Pull Handle 500mmW  
59217 Entrance myLOCK  
53736 Snib & Escutcheon Cover Plate  
59144 Double Cylinder 60mm

Matching Snib & Escutcheon Cover Plates for your feature entrance door to maintain uniformity through out your home.



Used in conjunction with myLOCK entrance security locks and cylinders.  
(Refer Security section).

# Aluminium



- 43966 Square Pull Handle
- 49204 Entrance Lock
- 43726 Square Escutcheon
- 49144 Double Cylinder



SC  
43966  
Pair back-to-back  
Aluminium

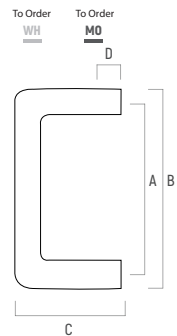

125mm Offset

- A 210mm
- B 250mm
- C 35 x Offset 125mm
- D 61mm



SC  
43964  
Pair back-to-back  
Aluminium



125mm Offset

- A 210mm
- B 250mm
- C 38 x Offset 125mm
- D 61mm

# Glass



43933  
Single  
Tempered Clear Glass

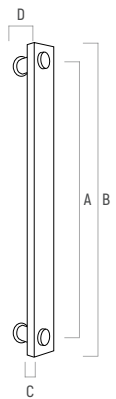

- A 495mm
- B 550mm
- C 12x55mm
- D 54mm

43934  
Pair back-to-back  
Tempered Clear Glass

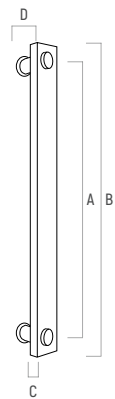

- A 495mm
- B 550mm
- C 12x55mm
- D 54mm

43931  
Single  
Tempered Clear Glass

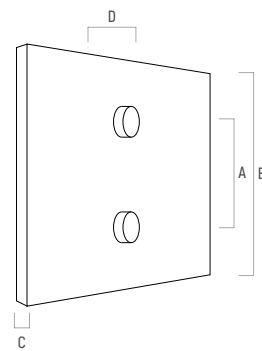

- A 100mm
- B 170x170mm
- C 15mm
- D 55mm

43932  
Pair back-to-back  
Tempered Clear Glass

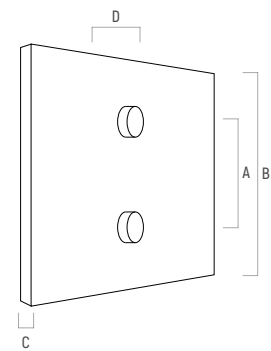

- A 100mm
- B 170x170mm
- C 15mm
- D 55mm



Pair back-to-back



304  
STAINLESS STEEL

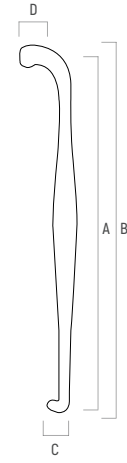

- A 573mm
- B 600mm
- C 38 x Offset 77mm
- D 70mm

Fixing Screws: M8 & M6  
Fitting Holes: 10mm diameter

PVD	RED	MB
13972	63972	53972





**MB**

53968

Pair back-to-back

Other Finishes available as a special order:

PSS WH MD PVD SSS

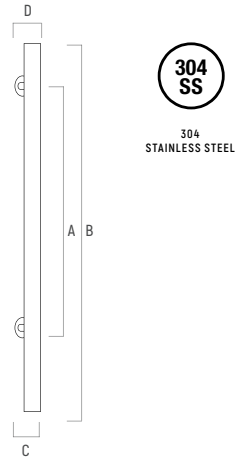

- A 700mm
- B 1100mm
- C 38 x Offset 75mm
- D 80mm

Fixing Screws: M8  
Fitting Holes: 10mm diameter



- 53702 52mm Round Escutcheon
- 59144 Double Cylinder 65mm



316  
STAINLESS STEEL



- 43820 Handle
- 43707 Escutcheon
- 49144 Double Cylinder 65mm
- 49207 Roller Lock

**Linear Entrance Pull Handle**  
Heavy Duty back to back thru fixing

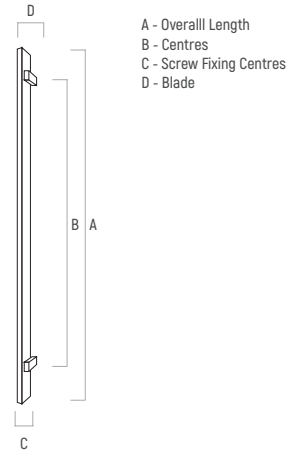

316 SSS		A	B	C	D
43816	Pair back-to-back	300	250	20x10	60
43817	Single	600	400	30x15	80
43818	Pair back-to-back	600	400	30x15	80
43820	Pair back-to-back	900	700	30x15	80

Other Finishes available as a special order:

**MB** **WH** **MO** **PVD** **SSS** **PSS**



304  
STAINLESS STEEL



### Circular Entrance Pull Handle Heavy Duty back to back thru fixing

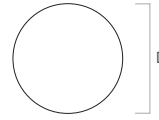

D - Diameter 230mm  
W - Handle Thickness 11mm  
P - Projection 50mm  
C - Centre To Centre Fixings 100mm

**MB**  
53994



**SB**  
93994



Other Finishes available as a special order:

**PSS** **WH** **MO** **PVD** **SSS**

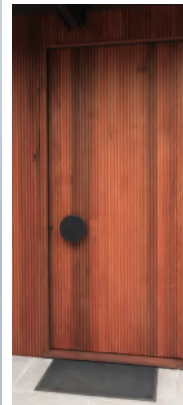
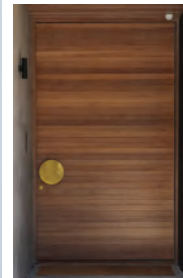



316  
STAINLESS STEEL

- 316SS Entrance Pull Handle 43814
- 316SS Lever Handle 42310
- 316SS Square Cover Plate 42329
- 304SS Escape Locks 49300
- 304SS Rebate Kit 49304
- Double Cylinder 49144
- Square Escutcheon 43726



316 SSS		A	B	C	D
43808	Pair back-to-back	450	300	25x25	65
43810	Pair back-to-back	600	400	25x25	65
43812	Pair back-to-back	900	600	25x38	78
43814	Pair back-to-back	1200	900	25x38	78



Other Finishes/Sizes available as a special order:

**MB** **WH** **MO** **PVD** **PSS**



316  
STAINLESS STEEL

### Slim Design



43824



### Square Design



53854



Australian Standard  
AS-1428 Compliant

316 SSS		A	B	C	D
43824	Pair back-to-back	400	370	30x15	70
43828	Pair back-to-back	800	770	30x15	70

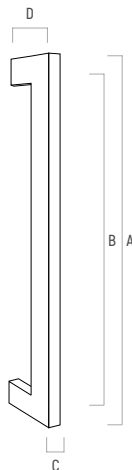

Other Finishes/Sizes available as a special order:

**MB** **WH** **MO** **PVD** **PSS**

316 SSS		A	B	C	D
43854	Pair back-to-back	450	425	25x25	66
43855	Pair back-to-back	600	575	25x25	66
43856	Pair back-to-back	1000	975	25x25	66



<b>MB</b>		A	B	C	D
53854	Pair back-to-back	450	425	25x25	66
53855	Pair back-to-back	600	575	25x25	66
53856	Pair back-to-back	1000	975	25x25	66

Other Finishes/Sizes available as a special order:

**PSS** **WH** **MO** **PVD**



316  
STAINLESS STEEL



43910



43916

### Oak Centre / Polished Ends

316 SSS		A	B	C	D
43910	Pairback-to-back	600	575	45	75



### Satin Centre / Polished Ends

316 SSS		A	B	C	D
43916	Pairback-to-back	600	575	45	68





316  
STAINLESS STEEL



43870



43866



SB  
93868

### Bowed Pull

316 SSS		A	B	C	D
43869	Single	300	150	25	72
43870	Pair back-to-back	300	150	25	72
43874	Pair back-to-back	600	400	32	96
43876	Pair back-to-back	900	600	38	101

Other Finishes/Sizes available as a special order:

- MB** **WH** **MO** **PVD** **PSS**



### Linear Tube

316 SSS		A	B	C	D
43866	Pair back-to-back	450	300	25	63
43867	Single	600	400	32	74
43868	Pair back-to-back	600	400	32	74
43872	Pair back-to-back	1000	800	32	74
<b>MB</b>					
53866	Pair back-to-back	450	300	25	63
53868	Pair back-to-back	600	400	32	74
53872	Pair back-to-back	1000	800	32	74
<b>SB</b>					
93866	Pair back-to-back	450	300	25	63
93868	Pair back-to-back	600	400	32	74

Other Finishes/Sizes available as a special order:

- PSS** **WH** **MO** **PVD**





316  
STAINLESS STEEL



43846



43882

Australian Standard  
AS-1428 Compliant

### Ergonomic Pull

316 SSS		A	B	C	D
43846	Pair back-to-back	450	300	32	78
43848	Pair back-to-back	600	300	32	78
43850	Pair back-to-back	900	600	38	78
43852	Pair back-to-back	1200	900	38	78

Other Finishes/Sizes available as a special order:

**MB** **WH** **MO** **PVD** **PSS**

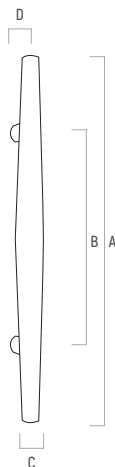

### Standard "D" Pull

316 SSS		A	B	C	D
43881	Single	350	325	25	74
43882	Pair back-to-back	350	325	25	70
43883	Single	600	562	38	90
43884	Pair back-to-back	600	562	38	90

Other Finishes/Sizes available as a special order:

**MB** **WH** **MO** **PVD** **PSS**

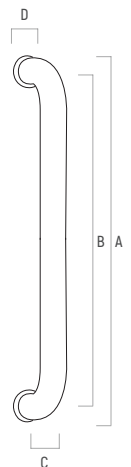





316  
STAINLESS STEEL



4382

43834  
300mm  
43737  
Integrated Round Snib &  
Escutcheon Set  
Used with 49211 myLock

Australian Standard  
AS-1428 Compliant



### Offset "D" Pull

316 SSS		A	B	C	Offset	E Projection
43833	Single	300	268	32	112	77
43834	Pairback-to-back	300	268	32	112	77
43842	Pairback-to-back	600	268	32	136	77
43843	Single	1300	1268	32	112	81
43844	Pairback-to-back	1300	1268	32	112	81

Other Finishes/Sizes available as a special order:

MB WH MO PVD PSS

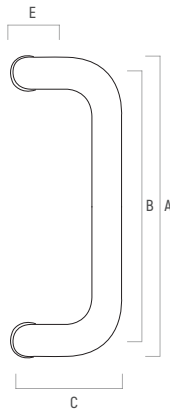

43924

### Offset Tube Pull

Offset 100mm

316 SSS		A	B	C	D
43921	Single	350	220	32	80
43922	Pairback-to-back	350	220	32	80
43924	Pairback-to-back	600	400	32	80

Other Finishes/Sizes available as a special order:

MB WH MO PVD PSS

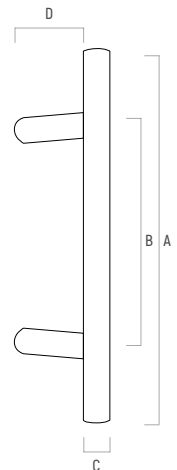



316  
STAINLESS STEEL



### Linear Square Design

Pair back-to-back

316 SSS	A	B	C
43995	450	430	40x20
43996	600	580	40x20
43997	1000	980	40x20

MB	A	B	C
53995	450	430	40x20
53996	600	580	40x20
53997	1000	980	40x20

316 SSS	Narrow Face		
43998	450	430	15x30
43999	600	585	15x30

MB	A	B	C
53998	450	430	15x30
53999	600	585	15x30



Other Finishes/Sizes available as a special order:

**PVD** **WH** **MO**

### Tapered Design

Pair back-to-back

316 SSS	A	B	C
43926	325	300	28x12.5
43928	475	450	28x12.5
43929	625	600	28x12.5
43930	1025	1000	28x12.5

MB	A	B	C
53926	325	300	28x12.5
53928	475	450	28x12.5
53929	625	600	28x12.5
53930	1025	1000	28x12.5

SB	A	B	C
93928	475	450	28x12.5
93929	625	600	28x12.5

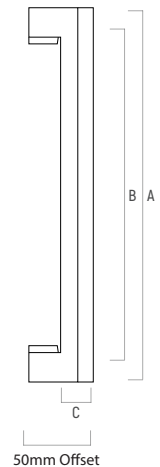



316  
STAINLESS STEEL



### Square Offset Design

Pair back-to-back

	A	B	C	D
316 SSS 43830	600 / cc575	120	25x25	50
MB 53830	600 / cc575	120	25x25	50
316 SSS 43840/325	325 / cc300	80	25x25	50
316 SSS 43840/475	475 / cc450	80	25x25	50
316 SSS 43840/625	625 / cc600	80	25x25	50
MB 53840/325	325 / cc300	80	25x25	50
MB 53840/475	475 / cc450	80	25x25	50
MB 53840/625	625 / cc600	80	25x25	50

Other Finishes/Sizes available as a special order:

PVD WH MO

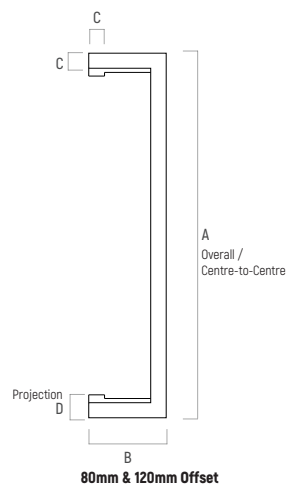

### Slim Offset Design

Pair back-to-back

	A	B	C	D	E	F
316 SSS 43960	450	425	100	50	30x15	30x30
MB 53960	450	425	100	50	30x15	30x30

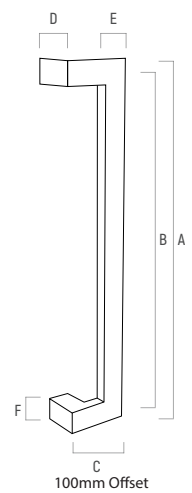

# Aluminium



## Blade Sliding Door Handle

Pair back-to-back  
Projection 40mm

SSS	A	B	C
43940	450	420	40x15
MB			
53940	450	420	40x15



Other Finishes/Sizes available as a special order:

PVD WH MD SB

## Blade Pull Handle

Pair back-to-back  
Projection 40mm

SSS	A	B	C
43936	450	420	40x15
MB			
53936	450	420	40x15
SB			
93936	450	420	40x15

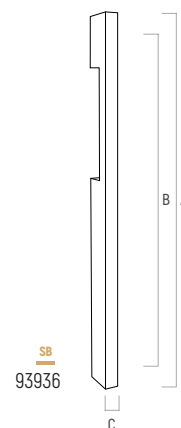

Other Finishes/Sizes available as a special order:

MD WH PSS

# Solid Brass



## Single Square Pull Handle

Heavy duty thru fixing

	A	B	P
<b>PB</b> 3183	100	100	60
<b>CP</b> 33183	100	100	60
<b>SC</b> 43183	100	100	60
<b>MB</b> 53183	100	100	60

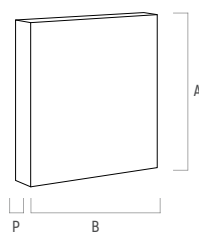

## Pull Handle Accessories

### Magnetic Door Catch

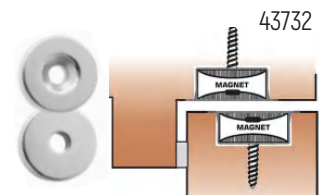

Earth magnets recessed into the frame and door hold the door firmly and securely in the closed position.

### Roller Catch Latch

- CP** 39026
- SC** 49026
- MB** 59026



Roller Latch assists to hold the door firmly and securely in the closed position.

### Pull Handle Fixing Legs

2 pcs

DIY Fixing legs accessory can be attached to timber or aluminium handles



25mm Diameter 40mm Length

- SC** 49878
- MB** 59878



# Security

# myLOCK

## ALL IN ONE Integrated Security: ROLLER LATCH, PRIVACY and DEAD BOLT.

Upgrade & Improve Your Entrance Security Without Changing Your Door.  
The new stainless steel body is designed to retro fit into the cavity of 85mm entrance mortice locks. Upgrade the security in your home without the need to change your door.

### 304 Stainless Steel

The casing, privacy & dead bolts, roller latch, spindle follower, internal components, faceplates and striker plates are manufactured in 304 high grade stainless steel for superior durability.

### The Indicator Snib

The direction of the snib provides a visual reference to indicate whether the privacy bolt (and the door) is in the locked or unlocked position.

### Adjustable SS Heavy Duty Roller Latch

After installation from the front of the roller latch; easily adjust the spring tension and projection of the roller to suit your desired opening tension.

suits austyle  
independent CAM  
cylinders only

### Keyless Locking

Using the snib when home will prevent anyone opening the door and walking in. It's a quick and simple locking function for every day use and works independently of the dead bolt.

### High Security Dead Bolt

Engage the dead bolt for the ultimate level of security when you're out of the house or away on holiday. A solid 304SS bolt that is 40mm high and 10mm thick and extends 85mm across the door jamb and back into the case will give you security and peace of mind.

### Independent CAM Cylinder & Integrated keylock

The independent CAM cylinder allows you to leave your key in the cylinder while still allowing its use from the outside of the door. Using your key to enter will simultaneously disengage both the privacy and dead bolt so you can enter in auSTYLE.



### myLOCK Roller Lock

	60mm Backset	30mm Backset	Rebate Kit Option	Face/Striker Spare Parts 60mm
<b>PVD</b>	19217		19220	19827
<b>ATQ</b>	29217		29220	29827
<b>PSS</b>	39217		39220	39827
<b>SSS</b>	49217	49214	49220	49827
<b>MB</b>	59217	59214	59220	59827
<b>COP</b>	69217			69827



## HOW TO ORDER

The 4 step process helps you combine the Roller Lock with the appropriate auStyle product to create a modern, clean entrance feature.

### STEP 1

Choose  
**myLOCK**  
Roller Lock  
x9217 or x9214

Add rebate kit if needed



### STEP 2

Choose  
Your  
Entrance  
Handle

See Feature Pull Handles P.37



### STEP 3

Choose  
Your Snib  
Escutcheon  
Design

See Security Section P.75



### STEP 4

Choose  
Your  
Cylinder  
Type

Requires a double cylinder



suits austyle independent CAM  
cylinders only  
Cylinders P.72



## ALL IN ONE Integrated Security: LEVER LATCH, PRIVACY and DEAD BOLT.

Upgrade & Improve Your Entrance Security Without Changing Your Door.  
The new stainless steel body is designed to retro fit into the cavity of 85mm entrance mortice locks.  
Upgrade the security in your home without the need to change your door.

### 304 Stainless Steel

The casing, privacy & dead bolts, latch, spindle follower, internal components, face plates and striker plates are manufactured in 304 high grade stainless steel for superior durability.

### The Indicator Snib

The direction of the snib provides a visual reference to indicate whether the privacy bolt (and the door) is in the locked or unlocked position.

### Quick Release Escape Function

Using the lever handle to open the door automatically disengages the privacy bolt for a quick keyless exit.

### 2 Hour Fire Tested Lock

### 2 Hour Fire Rated Cylinders

### Keyless Locking

Using the snib when home will prevent anyone opening the door and walking in. It's a quick and simple locking function for every day use and works independently of the dead bolt.

### High Security Dead Bolt

Engage the dead bolt for the ultimate level of security when you're out of the house or away on holiday. A solid 304SS bolt that is 40mm high and 10mm thick and extends 85mm across the door jamb and back into the case will give you security and peace of mind.

### Independent CAM Cylinder & Integrated keylock

The independent CAM cylinder allows you to leave your key in the cylinder while still allowing its use from the outside of the door. Using your key to enter will simultaneously disengage both the privacy and dead bolt so you can enter in auSTYLE.



### myLOCK Lever Lock

	60mm Backset	30mm Backset	Rebate Kit Option	Face/Striker Spare Parts 60mm
<b>PVD</b>	19219	19211	19220	19828
<b>ATQ</b>	29219		29220	29828
<b>PSS</b>	39219	39211	39220	39828
<b>SSS</b>	49219	49211	49220	49828
<b>MB</b>	59219	59211	59220	59828
<b>COP</b>	69219			69828



Rebate Adaptor Kit



## HOW TO ORDER

The 3 step process helps you combine the Lever Lock with the appropriate auStyle handle set to create a modern, clean entrance feature.

**STEP 1**  
Choose  
**myLOCK**  
Latch Lock  
x9219 or x9211

Add rebate kit if needed



**STEP 2**  
Choose  
Your Entrance  
Lever

DETERMINING THE HANDING  
Standing on the INSIDE and facing the door... Which way is the lever pointing?



See Door Handles Section P.19

**STEP 3**  
Choose  
Your  
Cylinder  
Type

Requires a double cylinder



suits austyle independent CAM  
cylinders only

Cylinders P.72 

# QuadLock

## Multi Function Entrance Lock ALL IN ONE 4 Modes of Operation

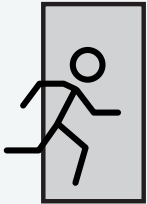

### Entrance Lock with full escape function

Internal: Lever Handle retracts the latch and bolt simultaneously for emergency exit.  
External: Lever Handle operates the latch to enter. Use a key to un/lock the bolt.

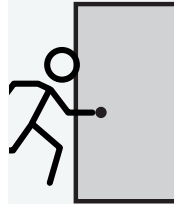

### Entrance Lock without escape function

Internal: Lever Handle operates the latch to exit. Use a key to un/lock the bolt.  
External: Lever Handle operates the latch to enter. Use a key to un/lock the bolt.

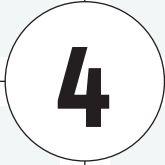

### Entrance Latch Function

Fire Door Exit Compliance  
Electric Strike Compatible

Disable the bolt so only the dead latch escape option is enabled.  
Internal: Lever handle retracts the latch for emergency exit.  
External: Use a key to retract the latch.

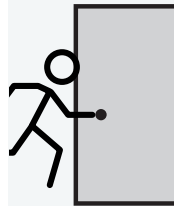

### Latching Function

Disable the bolt and escape function so the lock operates as a passage door latch.



**QuadLock**  
Escape Lock  
60mm Back set  
47.6mm C/C  
4 Modes Of Operation  
x9300



**QuadLock**  
Escape Lock  
30mm Back set  
85mm C/C  
4 Modes Of Operation  
x9311

	60mm Backset	Rebate Kit Option 60mm	Face/Striker Spare Parts 60mm	30mm Backset
PVD	19300	19304	19825	19311
ATQ	29300	29304		
PSS	39300	39304	39825	39311
SSS	49300	49304	49825	49311
MB	59300	59304	59825	59311

Rebate Kit Available x9304



Flat Latch Striker Plate  
Option Included with both  
Escape Locks



**Handle Features:**

-   
316 MARINE GRADE  
STAINLESS STEEL
-   
304 SS BALL BEARING  
RACE MECHANISM
-   
FIRE RATING  
4
-   
DDA  
COMPLIANT
-   
PATENTED

**QuadLock Features:**

-   
FIRE RATING  
4
-   
ELECTRIC STRIKER  
COMPATIBLE
-   
304  
SS  
STAINLESS STEEL
-   
ESCAPE  
FUNCTION
-   
LATCHING STRIKER  
OPTION INCLUDED
-   
PATENTED

**Cylinder Features:**

-   
FIRE RATING  
2
-   
INDEPENDENT  
CAM OPERATION

**4  
QuadLock**

# Security Locks Hinged Doors



FIRE RATING



DURABLE SECURITY



304 STAINLESS STEEL



PATENTED

## Residential Security Locks

Designed and Engineered in Australia

Heavy duty case and internal mechanical components.

Non combustible components

Simultaneously retracts latch when unlocking the door for a quick exit  
 Hardened steel rolling pins in bolt resist hacksawing - 24mm throw!  
 Reversible latch for either LH / RH opening doors

Simultaneously retracts latch when unlocking the door for a quick exit  
 Reversible latch for either LH / RH opening doors



47.6mm C/C  
 Cylinder sold separately

FIRE RATING	45mm Backset	60mm Backset	Rebate Kit Option
PB	9000	9001	19304
ATQ	29000	29001	29304
PSS	39000	39001	39304
SSS	49000	49001	49304
MB	59000	59001	59304



85mm C/C

49210

FIRE RATING	45mm Backset	60mm Backset	Rebate Kit Option
PB	9208	9209	19210
PSS	39208	39209	39210
SSS	49208	49209	49210
MB	59208	59209	59210

## Commercial Dead Latching Locks

Fire Door Exit Compliance when installed & used in dead latching mode  
 Electric Strike Compatible when installed & used in dead latching mode  
 Simultaneously retracts latch (and bolt) when unlocking the door for a quick exit



FIRE RATING



ESCAPE FUNCTION

**4**  
**QuadLock**  
 Refer P.66 For Functionality

Reversible latch for either LH / RH opening doors

47.6mm C/C



FIRE RATING	60mm Backset	Rebate Kit Option 60mm	Face/Striker Spare Parts 60mm
PVD	19300	19304	19825
ATQ	29300	29304	
PSS	39300	39304	39825
SSS	49300	49304	49825
MB	59300	59304	59825



Flat Latch Striker Plate Option Included



FIRE RATING	60mm Backset	Rebate Kit Option
SSS	49301	49304

## Commercial Narrow Back Set

85mm C/C



**25mm Backset**   **30mm Backset**   **Robate Kit Option**

SSS 49200   49201   49210



Refer P66 For Functionality

**PVD** 19311   **30mm Backset**

**PSS** 39311

**SSS** 49311

**MB** 59311

## Children Safety Screen Door Latch

Narrow 30mm back set / 42mm overall depth.  
Self latching snib latch for aluminium / timber doors  
Stainless steel latch / Satin Chrome (brass material) snibs



Use the #9809 conversion adaptor spindle to adapt the 49205 latch for use with any Austyle lever handle sets.



**Disabled & Child safety latch**  
Install at 1800mm from floor to prevent children opening doors

SSS 49205  
30mm Back Set

## Extended Striker Plates



**Generic Extension Striker** 100x25mm

SSS PSS  
49839 39839



**Suits All 85mm Locks**

304 SSS  
49840 85mm - 60mm Extension Lip  
49841 125mm - 60mm Extension Lip

**Suits Roller Locks**  
49842 125mm - 60mm Extension Lip

**MB**  
59840 85mm - 60mm Extension Lip  
59841 125mm - 60mm Extension Lip

**Suits Roller Locks**  
59842 125mm - 60mm Extension Lip

## Metal Frame Flush Fixings

Flush Fix Mounting Tabs Enable Locks To Be Flush Fixed Into Metal Frame Doors.



#9865 (1pair)  
50x25x10mm  
2 Optional Steps For Varying Face Plate Thicknesses (1mm & 2.5mm)

### WHY ARE AUSTYLE 304 STAINLESS STEEL SECURITY LOCKS BETTER?

Simply put, stainless steel offers significantly better durability and strength when compared with commonly available zinc or steel structured locks. Stainless steel contains higher levels of nickel providing superior corrosive resistance. Our locks are ideal for heavy duty, commercial applications and whenever superior quality and reliability is a significant consideration.



FIRE RATING   DURABLE SECURITY   304 STAINLESS STEEL   PATENTED

# Roller Latch Entrance Security



## Roller Latch & dead bolt - Timber Doors

Adjustable roller spring tension  
 Supplied with both LH and RH striker plates  
 Used in conjunction with entry handles, cylinders and escutcheons

## Roller Latch & dead bolt - Aluminium Doors

From adjustable roller spring tension  
 Heavy duty aluminium or timber door commercial applications  
 Supplied with both LH and RH striker plates



	45mm Backset	60mm Backset	Rebate Kit Option 60mm
SSS	49206	49207	49210
MB	59206	59207	59210



	57mm Backset	Escutcheon / cylinder sold separately
PB	9015	
ATQ	29015	
PSS	39015	
SSS	49015	
MB	59015	



	30mm Backset	Rebate Kit Option 60mm
SSS	49204	49210
MB	59204	59210



	30mm Backset	60mm Backset	Rebate Kit Option (60mm Only)
SSS	49214	PVD 19217	19220
MB	59214	ATQ 29217	29220
		PSS 39217	39220
		SSS 49217	49220
		MB 59217	59220
		CDP 69217	



## Self Latching Snib Latches

### Sliding Doors

Ideal for all Aluminium or timber self closing/latching sliding doors  
 Residential or commercial applications



Disabled & Child safety latch  
 Install at 1800mm from floor to prevent children opening doors



Includes 2 snibs 45mm diameter /28mm Backset

PVD	19027
PSS	39027
SSS	49027
MB	59027

### Hinged Doors

Ideal for all self closing/latching hinged doors  
 Residential or commercial applications



Disabled & Child safety latch  
 Install at 1800mm from floor to prevent children opening doors



Includes 2 snibs 40mm diameter / 60mm Backset

PVD	19018
PSS	39018
SSS	49018

# Sliding Doors Security



## Sliding Cavity Door Lock

Designed and Engineered in Australia  
 Heavy duty case and internal mechanical components.  
 Non combustible components  
 Heavy duty steel backing plate for additional strength and security  
 2 x Locating Pins guide the door into correct position when closing  
**45mm back set** - (Cylinder/escutcheon sold separately)

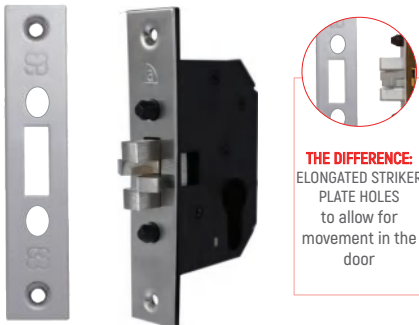

**THE DIFFERENCE:**  
 ELONGATED STRIKER  
 PLATE HOLES  
 to allow for  
 movement in the  
 door

	Euro Cylinder	5 Lever Skeleton Key
<b>PB</b>	9086	9084
<b>ATO</b>	29086	29084 Plated to order
<b>PSS</b>	39086	39084 Plated to order
<b>SSS</b>	49086	49084 Plated to order
<b>MB</b>	59086	59084 Plated to order

**myLOCK**  
 Integrated Keyless Privacy and High Security Dead Bolt Functionality.  
 Stainless Steel Non-combustible components  
 Heavy duty steel backing plate for additional strength and security  
**30mm back set**



	30mm Backset
<b>PVD</b>	19285
<b>PSS</b>	39285
<b>SSS</b>	49285
<b>MB</b>	59285

## Dead Bolt heavy duty

Heavy duty steel backing plate for additional strength and security  
 Suitable for either LH or RH opening doors  
 (49143 cylinder / 43702 escutcheon sold separately)  
**60mm back set**



	Euro Cylinder
<b>PB</b>	9012
<b>ATO</b>	29012
<b>PSS</b>	39012
<b>SSS</b>	49012
<b>MB</b>	59012

## Door Edge Pull

Use the edge pull to retrieve the door from its cavity.



## Integrated Flush Pull for entrance sliding doors

For fully recessed doors, use x3754E flush pulls together with a x9140 42mm cylinder on cavity sliding door with an entrance sliding door lock to allow the door to fully recess back into its cavity without compromising on security.

	Flush Pull 220x55x10mm
<b>SSS</b>	43754E
<b>MB</b>	53754E
	Cylinder 42mm Double
<b>SSS</b>	49140
<b>MB</b>	59140

	Sliding Door Lock (refer above)
<b>SSS</b>	49086 or 49285
<b>MB</b>	59086 or 59285

# Security Cylinders

## Keyed Cylinder Barrels



C4 euro profile

Available keyed alike - free of charge (ex stock SC only)

Approved for master keying

S/Steel internal springs for durability and reliability

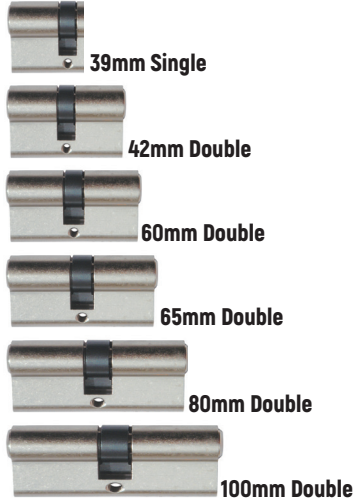

	39mm 3 Pin Single Cyl.	42mm 3 Pin Double	60mm 5 Pin Double	65mm 5 Pin Double	70mm 5 Pin Double	80mm 5 Pin Double	100mm 5 Pin Double
<b>PVD</b>	-	-	19143	19144	-	-	-
<b>PB</b>	9142	-	9143	9144	9147	9148	9150
<b>ATQ</b>	29142	-	29143	29144	-	-	-
<b>CP</b>	39142	-	39143	39144	39147	39148	39150
<b>SC</b>	49142	49140	49143	49144	49147	49148	49150
<b>MB</b>	59142	59140	59143	59144	59147	59148	59150
<b>SB</b>				99144			



## Turn Snib & Key Cylinder Barrels

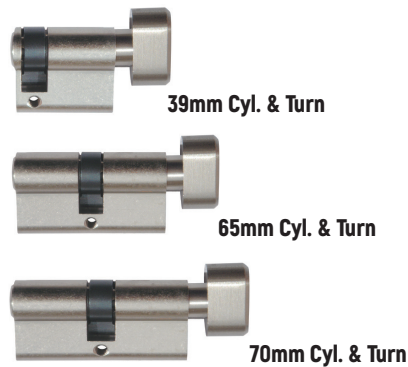

	39mm Cyl. & Turn	65mm 5 Pin Cyl. & Turn	70mm 5 Pin Cyl. & Turn
<b>PVD</b>	-	19145	-
<b>PB</b>	9141	9145	-
<b>ATQ</b>	-	29145	-
<b>CP</b>	39141	39145	-
<b>SC</b>	49141	49145	49149
<b>MB</b>	59141	59145	59149



## Euro Profile Privacy Adapter

Use the adaptor to convert any of the high security locks to use with privacy snibs for low security privacy or bathroom door applications.

Refer page 77 for all available snib styles.

Euro Profile  
Privacy  
Adapter  
9848

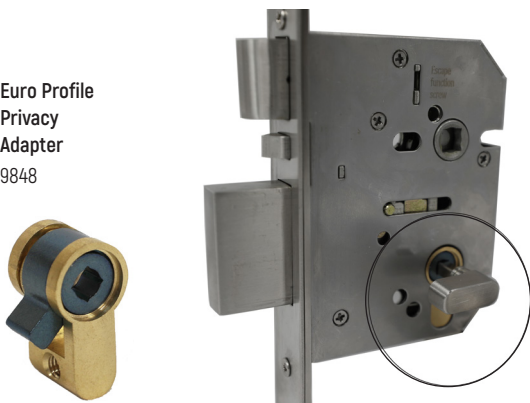

When using with long plate furniture,  
Please specify the privacy spacing  
position required to suit either 47.6mm or  
85mm C/C locks as follows:

PRIVACY  
47.6mm C/C

XXXXPA



PRIVACY  
85mm C/C

XXXXPE



## Key Blanks

Cylinder Keys

9845-KEY5 5 Pin

9845-KEY6 6 Pin





# Passage Door Latches



MECHANICAL WARRANTY

## Passage Latch heavy duty "D" Strike



	60mm Single Spring	60mm Double Spring
<b>PB</b>	9031	9030
<b>ATQ</b>	29031	29030
<b>CP</b>	39031	39030
<b>SC</b>	49031	49030
<b>MB</b>	59031	59030
<b>COP</b>	69031	

## Separate Rebate adaptor kit



<b>PB</b>	9025
<b>ATQ</b>	29025
<b>CP</b>	39025
<b>SC</b>	49025
<b>MB</b>	59025

Suits Austyle Latches & Privacy Bolts

## Passage Latch "T" Striker

Split Follower



	45mm Single Spring	60mm Single Spring
<b>PB</b>	9028	-
<b>ATQ</b>	-	-
<b>CP</b>	39028	-
<b>SC</b>	49028	49028
<b>MB</b>	59028	-

## Magnetic Latch for a clean door edge



60mm Depth  
50mm Backset  
The magnet ejects & retracts automatically with the operation of the handle. Includes box striker for a neat professional finish.

**SC** 49024

# Passage Door Catches

304 SS  
304 STAINLESS STEEL

## Roller Catch Latch



Roller Latch assists to hold the door firmly and securely in the closed position.

<b>CP</b>	39026
<b>SC</b>	49026
<b>MB</b>	59026

## Magnetic Door Catch

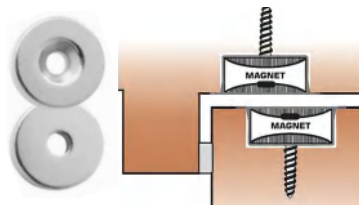

Earth magnets recessed into the frame and door hold the door firmly and securely in the closed position.

**SC** 43732

**TIP:** Highly Recommended for use on all pivot or hinged doors where a roller lock is installed to assist in holding the door firmly in position.

## Ball Catch/Latch



Ball catch assists to hold the door firmly and securely in the closed position.

<b>PB</b>	3731
<b>CP</b>	33731
<b>SC</b>	43731

# Escutcheon Covers



Cylinder sold separately



Rectangle Concealed  
70x70mm  
10mm Projection

<b>304 SS</b>	<b>PVD</b>	13724
	<b>PSS</b>	33724
	<b>SSS</b>	43724
	<b>MB</b>	53724
	<b>WH</b>	83724



Oval Concealed  
70x70mm  
10mm Projection

<b>304 SS</b>	<b>PVD</b>	13725
	<b>PSS</b>	33725
	<b>SSS</b>	43725
	<b>MB</b>	53725
	<b>WH</b>	83725



53702 Escutcheon



Square Edge 52mm 8mm Projection	
<b>PB</b>	3702
<b>ATQ</b>	23702
<b>CP</b>	33702
<b>SC</b>	43702
<b>MB</b>	53702
<b>WH</b>	83702
<b>SB</b>	93733

Square Edge 45mm 8mm Projection	
	3701
	23701
	33701
	43701
	53701
	83701

Square Edge 45mm 8mm Projection	
	3700
	-
	33700
	43700
	53700
	83700



Square 40x40mm 8mm Projection	
<b>PB</b>	3726
<b>ATQ</b>	23726
<b>CP</b>	33726
<b>SC</b>	43726
<b>MB</b>	53726
<b>WH</b>	83726

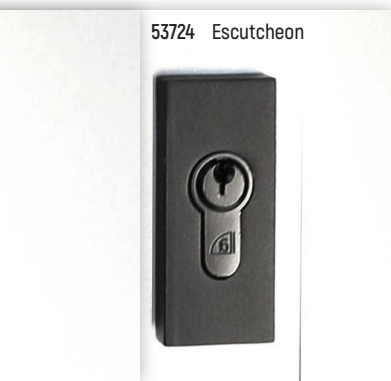

53724 Escutcheon



<b>316 SS</b>	
316 STAINLESS STEEL	
Square Edge 52mm 3mm Projection Concealed Fix Solid Cast 316SS	
<b>316 SSS</b>	43704



Rounded Edge 52mm 8mm Projection	
<b>PVD</b>	13703
<b>CP</b>	33703
<b>SC</b>	43703
<b>MB</b>	53703



Square Oval Profile 52x52mm 8mm Projection Concealed Fix	
<b>SC</b>	43537
<b>MB</b>	53537



Blank Concealing Cover 52mm 8mm Projection	
<b>CP</b>	33709
<b>SC</b>	43709
<b>MB</b>	53709



Square Oval Ovl. 50x50mm 8mm Projection	
<b>SC</b>	43537
<b>MB</b>	53537



Square Euro Profile 52x52mm 8mm Projection Concealed Fix	
<b>SC</b>	43538
<b>MB</b>	53538



Square Edge Oval Cyl. 8mm Projection			
	52mm	45mm	40mm
<b>PVD</b>	13707	13706	13705
<b>CP</b>	33707	33706	33705
<b>SC</b>	43707	43706	43705
<b>MB</b>	53707	53706	53705
<b>WH</b>	83707	83706	83705



Round Edge Oval Cyl. 8mm Projection 52mm	
<b>PVD</b>	13708
<b>CP</b>	33708
<b>SC</b>	43708
<b>MB</b>	53708
<b>WH</b>	83708

# Finishing Options: Integrated "Keyless" Snib & Escutcheon



Create a clean minimal entrance using a snib & escutcheon set to operate high security locks for front/external doors.

The snib operates the lock in the same way a conventional lever handle functions, opening the door from the inside with a turn of the snib.

Externally, use a key to simultaneously retract the latch and open the door.

Simple. Practical daily functionality.



## Snib & Escutcheon Sets

304 Stainless Steel Plates. 145x40mm. Includes external escutcheon plate. Cylinders sold separately p.72.



### 4 QuadLock

Suits: x9300  
Lever Locks  
(p.68)  
47.6mm

- 13735 **PVD**
- 23735 **ATQ**
- 33735 **PSS**
- 43735 **SSS**
- 53735 **MB**
- 63735 **COP**

### myLOCK

Suits: x9217  
Roller Locks  
(p.70)  
85mm

- 13736 **PVD**
- 23736 **ATQ**
- 33736 **PSS**
- 43736 **SSS**
- 53736 **MB**
- 63736 **COP**
- 93736 **SB**

Round Integrated Snib Set  
45mm diameter

### myLOCK

Suits: x9217  
85mm

- 23737 **ATQ**
- 43737 **SSS**
- 53737 **MB**



Rectangle Integrated Snib Set  
100x40mm

### myLOCK

Suits: x9217  
85mm

- 23734 **ATQ**
- 43734 **SSS**
- 53734 **MB**



External Side  
Concealed Screw Head  
For Tamper Proof Fixing

# Bathroom Locking Options

## Bathroom Privacy Door Latch Recessed Cavity Sliding Doors

Ideally used in situations where the cavity door recesses all the way back inside the door frame. These flush pulls are recessed into the door face allowing the door to fully recess into its cavity. Matching flush pulls for lockable and passage doors available on page 41 for aesthetic consistency.

### Integrated privacy flush pull



43754P

### Recessed flush turn snibs



### Non-Recessed snibs



59038 & 59033



53754P

Refer opposite page for all snib style options



**Integrated Flush Pull & Latch Set**  
Flush Pull 220x55mm  
Includes 60mm Latch

304 SSS	43754P	49041
MB	53754P	59041

**Sliding Door Latch (Only)**  
60mm Back Set  
80mm Overall

Locating pin guides the door into its correct position when closing.



**Concealed Fix Flush Turn Snib Set**  
40mm Diam

PVD	9040	9033
ATQ	29040	29033
CP	39040	39033
SC	49040	49033
MB	59040	59033

**Sliding Door Latch**  
53mm Overall  
37mm C/C

## Euro Privacy Snib Adapter

Use the adaptor to convert any of the high security locks to use with privacy snibs for low security privacy or bathroom door applications.

Refer page 77 for all available snib styles.

**Euro Profile Privacy Adapter**

9848  
Refer p.72 for ordering details



### Bathroom Sliding Door



**Flush Pull**

PB	9049	9050
ATQ	29049	29050
CP	39049	39050
SC	49049	49050

**Flush Latch Pull**

## Self Latching Snib Latch

Ideal for all ALUMINIUM or timber self closing/latching sliding doors  
Residential or commercial applications



**28mm Backset**  
**45mm Overall**  
45mm Diam Snibs

PB	9027
CP	39027
SC	49027
MB	59027

## Bathroom Indicator Bolts

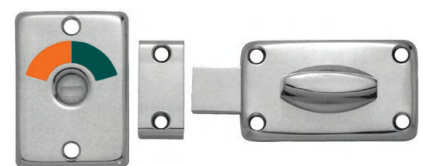

**Latch**  
40mm x 68mm

CP	39014
SC	49014

# Bathroom Privacy Door Latch (Hinged Doors)

60mm back set

- 9032 **PVD**
- 29032 **ATO**
- 39032 **PSS**
- 49032 **SSS**
- 59032 **MB**
- 69032 **CDP**



MECHANICAL WARRANTY



Used in conjunction with all snib options below.

## Privacy Snib Styles

Ideal for hinged or sliding doors / concealed & thru fix options / Ideal for semi-recessed sliding doors

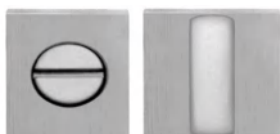

Square Concealed Fix  
40x40mm

- CP** 9046
- SC** 49046
- MB** 59046

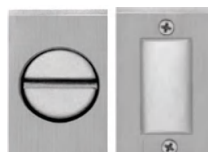

Rectangle Semi  
Conceald Fix  
42x25mm

- PB** 9037
- CP** 39037
- SC** 49037
- MB** 59037



Round Concealed  
Conceald Fix  
50mm diam.

- SC** 43531CL
- MB** 53531CL



Square Concealed  
Conceald Fix  
50x50mm

- SC** 43531CL
- MB** 53531CL



Round  
Concealed Fixing  
40m Diam.

- PB** 9038
- ATO** 29038
- CP** 39038
- SC** 49038
- MB** 59038



**Ideal for cavity sliding doors**

Concealed Fixing  
45m Diam.

- PB** 9040
- CP** 39040
- SC** 49040
- MB** 59040
- SB** 99040



Rectangle Snib Set  
Thru Fixing  
40x25m Diam.

- PB** 9034
- ATO** 29034
- CP** 39034
- SC** 49034
- MB** 59034



Round Snib Set  
Thru Fixing  
45m Diam.

- PB** 9035
- ATO** 29035
- CP** 39035
- SC** 49035
- MB** 59035



**Square Double Snib Set**

Concealed Fixing  
40x40mm

- SC** 49045
- MB** 59045



**Round Double Snib Set**

Concealed Fixing  
40m Diam.

- PB** 9044
- CP** 39044
- SC** 49044
- MB** 59044



# Flush Pulls

# Flush Pulls



304  
STAINLESS STEEL

Ideal for all bi-fold  
Sliding or cavity doors



70x70mm  
12mm Depth  
304 SSS 43750  
MB 53750

50x50mm  
12mm Depth  
304 SSS 43751  
MB 53751

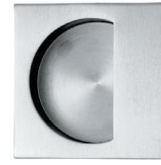

70x70mm  
12mm Depth  
304 SSS 43742  
MB 53742



90mm Diam.  
19mm Depth  
304 SSS 43743  
MB 53743



65mm Diam.  
12mm Depth  
304 SSS 43741  
MB 53741



Used in conjunction with  
passage latch (x9031) and  
most 60mm backset locks.  
76mm Diam.  
14mm Depth  
304 SSS 43746  
MB 53746



45x63mm  
7mm Depth  
PSS 33747  
304 SSS 43747  
MB 53747



Longer architectural sizes assist to accentuate the height of the door and room.  
Ideal for timber or aluminium doors.

320x55mm  
12mm Depth  
304 SSS 43753  
MB 53753

220x55mm  
12mm Depth  
304 SSS 43752  
MB 53752

150x50mm  
12mm Depth  
304 SSS 43749  
MB 53749  
SB 93749

100x50mm  
12mm Depth  
PSS 33745  
304 SSS 43745  
MB 53745





304  
SS

304  
STAINLESS STEEL

Concealed fixing with an internal finger grip



**100x50mm**  
12mm Depth

PSS	33745
304 SSS	43745
MB	53745

**150x50mm**  
12mm Depth

304 SSS	43749
MB	53749
SB	93749

**220x55mm**  
12mm Depth

304 SSS	43752
MB	53752

**320x55mm**  
12mm Depth

304 SSS	43753
MB	53753



**220x55mm**  
10mm Depth

304 SSS	43754E
MB	53754E

Integrated Cylinder Hole  
(Per Pair)



**220x55mm**  
10mm Depth

304 SSS	43754
MB	53754

(Per Pair)



Concealed fixing

**100x50mm**  
12mm Depth

304 SSS	43739
MB	53739



**120x40mm**  
12mm Depth

304 SSS	43740
MB	53740



Concealed fixing

**120x40mm**  
12mm Depth

304 SSS	43744
MB	53744

**NARROW (35mm) SLIM LINE FLUSH PULL**

Concealed grub screw fixing  
Moulded Solid 304SS without internal edges



**200x35mm**  
14mm Depth

304 SSS	43755
MB	53755

Concealed Grub  
Screw Fixing

Without Internal  
Edge Grip



Pictured:

53755	Black Flush Pull
53726	Black Square Escutcheon
59145	Black Cylinder Turn

**DOOR EDGE PULL HANDLE**

Ideal for heavier doors, the integrated ergonomic handle will assist in retrieving the door from its cavity.



**115x25mm**

PB	4456
CP	34456
SC	44456
MB	54456

**DOOR EDGE PULL**

Use the edge pull to retrieve the door from its cavity.  
Concealed Fixing



**75x55mm**  
40mm Pull

SSS  
44455

MB  
54455

SB  
94455



# Joinery Handles

# Joinery Handles



304  
STAINLESS STEEL

High Grade 304 Solid  
Stainless Steel

Minimal 7.8% Nickel content  
for Strength, Durability and  
Corrosion resistance

Includes:  
2 x 40mm M4 screws with  
snap off points



L - Overall Length  
C - Screw Fixing Centres  
P - Projection  
D - Diameter

304  
SSS

## Handle 1 - Square

	L	C	D	P
48784	115	55	10x20	30
48785	160	100	10x20	30
48786	210	150	10x20	30
48787	260	200	10x20	30
48788	360	300	10x20	30
48789	460	400	10x20	30
48790	560	500	10x20	30
48791	660	600	10x20	30
48792	860	700	10x20	30

304  
SSS

## Handle 4 - Round

	L	C	D	P
48750	75	74	10	30
48751	107	98	10	30
48753	170	171	10	30
48754	107	98	12	32
48755	137	126	12	32
48756	170	159	12	32
48757	300	287	12	32
48758	362	351	12	32

304  
SSS

## Handle 8 - Square

	L	C	D	P
48800	100	80	6x15	30
48801	130	120	6x15	30
48802	160	140	6x15	30
48803	200	180	6x15	30
48804	300	280	6x15	30
48794	130	110	6x20	30
48795	160	140	6x20	30
48797	300	280	6x20	30
48798	400	380	6x20	30
48799	500	480	6x20	30

304  
SSS

## Handle 2 - Square

	L	C	D	P
48708	113	63	12x12	40
48709	146	96	12x12	40
48711	260	210	12x12	40
48712	356	306	12x12	40
48714	452	402	12x12	40
48716	550	500	12x12	40
48717	650	600	12x12	40
48690	113	63	8x8	38
48691	146	96	8x8	38
48692	196	146	8x8	38
48693	260	210	8x8	38
48694	356	306	8x8	38
48695	452	402	8x8	38
48696	550	500	8x8	38

304  
SSS

## Handle 5

	L	C	D	P
48771	152	140	8	33
48772	185	173	8	33
48773	240	218	8	33
48774	326	314	8	32

304  
SSS

## Handle 9

	L	C	D	P
48750	83	74	10	30
48751	107	98	10	30
48753	170	161	10	30
48754	107	98	12	32
48755	137	126	12	32
48756	170	159	12	32
48757	300	287	12	32
48758	362	351	12	32

304  
SSS

## Handle 3 - Square

	L	C	D	P
48699	120	108	12x12	30
48700	170	158	12x12	30
48701	212	200	12x12	30
48704	512	500	12x12	30
48706	812	800	12x12	30

304  
SSS

## Handle 6

	L	C	D	P
48759	106	86	8	35
48761	154	134	8	35
48762	186	166	8	35

304  
SSS

## Handle 7

	L	C	D	P
48718	146	96	10	30
48719	196	146	10	30
48720	210	160	10	30
48721	250	200	10	30
48722	300	250	10	30
48723	350	300	10	30
48724	400	350	10	30
48725	450	400	10	30
48728	146	96	12	30
48729	196	146	12	30
48730	210	160	12	30
48731	250	200	12	30
48732	300	250	12	30
48733	350	300	12	30
48736	550	500	12	30
48737	650	600	12	30

**SB**

## Cabinet Pull Handle

98702  
12 x 12mm x 236mm

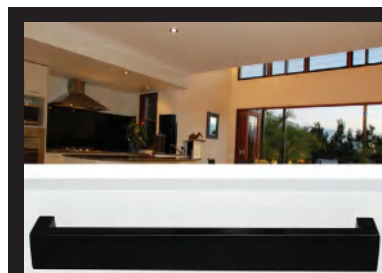

TO  
ORDER  
**MB**

"Ask us about  
Black Powder Coated  
Options for most handles in  
the range"



TO  
ORDER  
**MB**



austyle architectural hardware



Handle 1



Handle 2



Handle 3



Handle 4



Handle 5



Handle 6



Handle 7



Handle 8



Handle 9

# Drawer Pull Handles

TO  
ORDER  
**MB**

Includes:  
2 x 40mm M4 screws  
with snap off points



96mm - centres **PB**  
128mm - centres **CP** **SC**  
38532 48532



96mm - centres **CP** **SC**  
128mm - centres 38521 48521  
38522 48522



96mm - centres **CP** **SC**  
128mm - centres 38528 48528  
38529 48529



96mm - centres **CP** **SC**  
128mm - centres 38518 48518  
48519



96mm - centres **CP** **SC**  
128mm - centres 38526 48526  
48527



96mm - centres **CP** **SC**  
128mm - centres 38534 48534  
48535



96mm - centres **CP** **SC**  
38523 48523



96mm - centres **CP** **SC**  
38509 48509



96mm - centres **CP** **SC**  
38513 48513



96mm **CP**  
35604



96mm - centres **SC**  
48504



64mm - centres **CP** **SC**  
96mm - centres 38505 48505  
128mm - centres **CP** **SC**  
38506 48506  
38507 48507



50x20mm **CP** **SC**  
86x35mm 38576 48576  
38577 48577



43x20mm **SC**  
48565



75x18mm **PB** **CP** **SC**  
3286 33286 43286



75x18mm **SC**  
43293



96mm

## Concealed Flush Drawer Pull

**SSS** **MB**  
116mm 48200 58200  
166mm 48201 58201  
190mm 48201 58201

Thickness: 1.5 mm

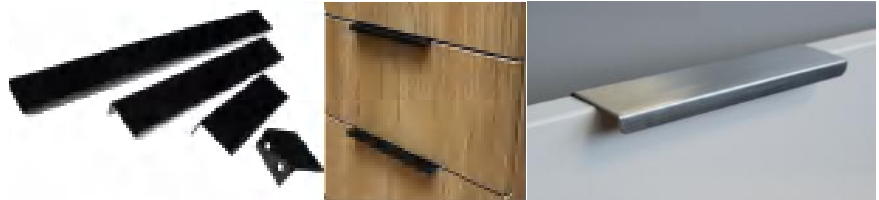



20x20mm **PB** **CP** **SC**  
 8662 38662 48662  
 25x25mm **PB** **CP**  
 8663 38663  
 30x30mm **PB** **CP** **SC**  
 8664 38664 48664



25x25mm **CP**  
 38567



40x23mm **CP** **SC**  
 38555 48555



35x28mm **PB** **CP** **SC**  
 38575 48575 48575



25x25mm **CP**  
 38679  
 30x25mm **PVD** **CP** **SC**  
 18678 38678 48678  
 35x30mm **PVD** **CP** **SC**  
 18679 38679 48679



25x25mm **CP** **SC**  
 38659 38659  
 32x32mm **CP** **SC**  
 38660 38660  
 35x33mm **CP**  
 38553



28x27mm **CP**  
 38560  
 33x27mm **CP**  
 38561



8666 20x27mm **PB** **CP** **SC**  
 8666 38666 48666  
 8667 25x30mm **PB** **SC**  
 38667 48667



25x25mm **PVD** **CP** **SC**  
 18674 38674 48674  
 30x27mm **PVD** **CP** **SC**  
 18675 38675 48675



8671 25x22mm **PVD** **CP** **SC**  
 18671 38671 48671  
 8672 30x28mm **PVD** **CP** **SC**  
 18672 38672 48672



8651 22x20mm **PB** **CP** **SC**  
 8651 38651 48651  
 8652 28x26mm **PB** **CP** **SC**  
 8652 38652 48652



8584 16x20mm Aluminium **SC**  
 48584  
 8585 20x26mm Aluminium **SC**  
 48585



18x25mm Solid Brass **SC**  
 48654  
 21x27mm Aluminium **CP** **SC**  
 38655 48655



15x22mm Aluminium **SC**  
 48580  
 20x26mm Aluminium **SC**  
 48581



32mm **PB** **CP** **SC**  
 8601 38601 48601



35x20mm **CP** **SC**  
 38563 48563  
 47x27mm **CP**  
 38564



25x30mm **CP** **SC**  
 38557 48557  
 35x40mm **CP** **SC**  
 38558 48558







# Hinges

# Hinges



FIRE RATING



304 STAINLESS STEEL

Sold in pairs

All hinges include stainless steel/brass phillips head wood screws

M5/12mm metal thread screws available (#9900)

PVD hinges are warranted against tarnishing for 50 years. A highly polished brass finish on a durable stainless steel base provides outstanding strength, long term durability without the worry of corrosion

## Square Knuckle Hinges

## Standard Hinges



316 STAINLESS STEEL

Brushed Stainless Steel

316 SSS

- 45316 100x75x2.5mm Fixed Pin
- 45317 100x100x2.5mm Fixed Pin
- 45318 100x75x2.5mm LoosePin



Brushed Stainless Steel

304 SSS

- 45105 85x60x2mm Fixed Pin
- 45107 100x60x2mm Fixed Pin
- 45108 100x75x2.5mm Fixed Pin
- 45109 100x100x2.5mm Fixed Pin
- 45115 85x60x2mm LoosePin
- 45118 100x75x2.5mm LoosePin



PVD Polished Brass

PVD

- 15108 100x75x2.5mm Fixed Pin
- 15109 100x100x2.5mm Fixed Pin
- 15117 100x60x2mm LoosePin
- 15118 100x75x2.5mm LoosePin



Satin Brass

SB

- 95108 100x75x2.5mm Fixed Pin
- 95109 100x100x2.5mm Fixed Pin



Brass Material

SC

- 45120 100x75x2.5mm



Antique Copper

ATO

- 25008 100x75x2.5mm Fixed Pin
- Solid Brass Material - Fire rating not applicable



Matt Black

MB

- 55108 100x75x2.5mm Fixed Pin
- 55109 100x100x2.5mm Fixed Pin
- 55115 85x60x2mm LoosePin
- 55118 100x75x2.5mm LoosePin



Brass Material

MB

- 55120 100x75x2.5mm



White

WH

- 85118 100x75x2.5mm LoosePin



Bright Polished Stainless Steel

PSS

- 35108 100x75x2.5mm Fixed Pin
- 35109 100x100x2.5mm Fixed Pin
- 35115 85x60x2mm LoosePin
- 35118 100x75x2.5mm LoosePin

# Heavy Duty Broad Butt Fixed Pin Hinges

Ideally suited for "wider/long" reach or to pass a reveal or extended throw

M5/12mm metal thread screws available (#9900)

PVD hinges are warranted against tarnishing for 50 years.

Sold in pairs



**304 SSS**  
 45112 100x125x3mm  
 45111 100x150x3mm  
 45110 100x175x3mm  
 45113 100x200x3mm



**PSS**  
 35112 100x125x3mm  
 35111 100x150x3mm  
 35110 100x175x3mm



**PVD**  
  
 15112 100x125x3mm  
 15111 100x150x3mm  
 15110 100x175x3mm



**MB**  
 55112 100x125x3mm  
 55111 100x150x3mm  
 55110 100x175x3mm

# Heavy Duty 4 Ball Bearing Hinges



Sold as Singles

304 SS BALL BEARING



45508 100x75x2.5mm **304 SSS**



35508 100x75x2.5mm **PSS**



55508 100x75x2.5mm **MB**

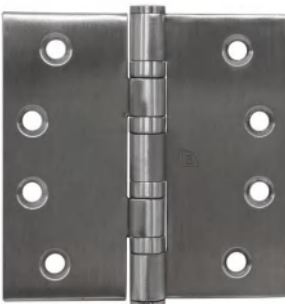

45509 100x100x2.5mm **304 SSS**



35509 100x100x2.5mm **PSS**



55509 100x100x2.5mm **MB**



## Fast Fix Hirline Flush Hinges

No rebating required

Ideal for timber or aluminium applications

M5/12mm metal thread screws available (#9900)

Heavy duty stainless steel ball bearings

PVD hinges are warranted against tarnishing for 50 years.

Sold in Pairs

304 SS BALL BEARING  
RACE MECHANISM

316  
SS

316  
STAINLESS STEEL



316  
SSS

45344 100x47x2.5mm



304  
SSS

45144 100x47x2.5mm



PSS

35144 100x47x2.5mm



PVD

15144 100x47x2.5mm



MB

55144 100x47x2.5mm



304  
SSS

45143 89x35x2mm



Small Size Non-Bearing

304  
SSS

45142 76x30x1.5mm



## Fast Fix Hirline Aluminium Hinges

No rebating required

Ideal for timber or aluminium applications

M5/12mm metal thread screws available (#9900)

Heavy duty stainless steel ball bearings

Sold as Singles



45444 100x48x3.2mm 304  
SSS



55444 100x48x3.2mm MB



## Long Body Hinges

Heavy Duty 4 Ball Bearing Butt Hinge

Extended 150mm body and 3mm thickness for additional strength.

Door Weight Recommendations: 2pcs/40kgs 3pcs/60kg

Sold as Singles



45514 150x88x3mm 304  
SSS



55514 150x88x3mm MB



## Radius Hinges

Radius corners for simple & easy installation using a router.

Heavy Duty 2 Ball Bearing Hinges

Door Weight Recommendations: 2pcs/40kgs 3pcs/60kg

Sold in Pairs



304  
SSS

45408 100x75x2.5mm

45409 100x100x2.5mm



MB

55408 100x75x2.5mm

55409 100x100x2.5mm

# Universal Lift Off Hinge - All Toilet / Bathroom Doors

Used for all residential or commercial toilet/bathroom door applications

Used for either LEFT or Right handed opening doors

"Frame" and "Door" marked on the hinge to make installation simple and easy

12mm Pin for easy removal of the door

Sold as Singles



45239 100x75x2.5mm 304 SSS



35239 100x75x2.5mm PSS



15239 100x75x2.5mm PVD



55239 100x75x2.5mm MB

## Lift Off Hinge

Required for all domestic/commercial bathroom door installations

12mm pin length (lift off distance) for quick and easy lifting

M5/12mm metal thread screws available (#9900)

PVD hinges are warranted against tarnishing for 50 years.

Sold in Pairs

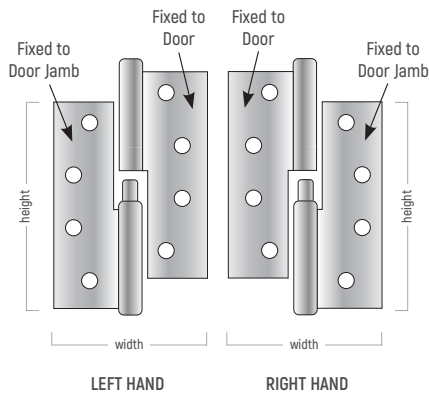

## Self Closing Rising Hinge

Suits all domestic/commercial bathroom installations

M5/12mm metal thread screws available (#9900)

Sold in Pairs

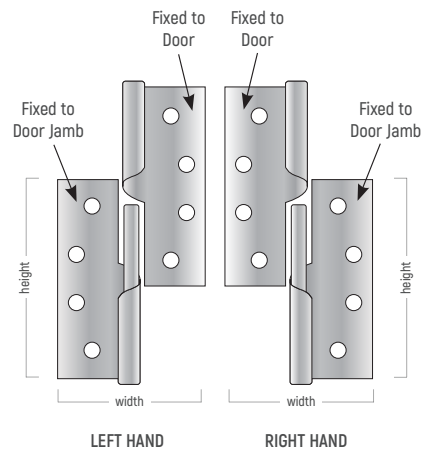

SSS  
45130 89x60x2.5mm Left Hand  
45131 89x60x2.5mm Right Hand



PVD  
15130 89x60x2.5mm Left Hand  
15131 89x60x2.5mm Right Hand



SSS  
45134 100x75x2.5mm Left Hand  
45135 100x75x2.5mm Right Hand



# Door & Window Bolts

## Flush Bolts

## Panic Bolts

# Flush, Panic, Door Window Bolts

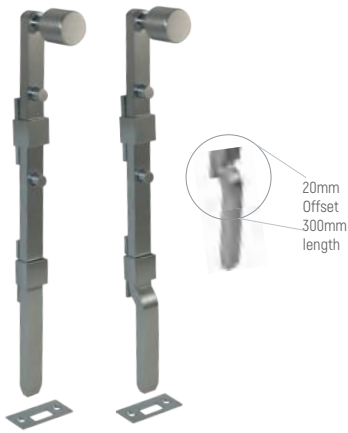

## Panic Bolt - Heavy Duty

Reinforced solid saddle for additional strength  
Solid brass and heavy duty fixings  
Concealed fixing

	225mm	300mm	300mm Offset	450mm	600mm
<b>PB</b>	5025	5026	5046	5027	5028
<b>CP</b>	35025	35026	35046	35027	35028
<b>SC</b>	45025	45026	45046	45027	45028



## Lockable High Security Flush Bolt

200x30mm

<b>PB</b>	5195
<b>SC</b>	45195

15mm Flush Bolt Depth  
22mm Cylinder Recess depth  
Supplied with interchangeable buttons for both hinged doors or stackable sliding doors  
C4 Cylinder profile can be re-keyed to match existing cylinders  
Heavy Duty Solid Brass material



Both bolts include multiple housing options



## Spring Loaded Window or Door Bolt

<b>CP</b>	39112	40x42mm
<b>CP</b>	39111	135x42mm

Concealed design & upgraded spring mechanism  
C4 cylinder key  
Spring loaded bolt release  
31mm Projection



## Spring Loaded Barrel Bolt - Heavy Duty

20mm bolt throw

<b>SC</b>	49121	85x42mm
-----------	-------	---------

Push Button Release

## Accessories



### Angle & Floor Keepers

For flush /barrel bolts

<b>PB</b>	<b>CP</b>	<b>SC</b>	<b>MB</b>
4305	34305	44305	54305



### Flat Keeper

For panic bolts

<b>PB</b>	<b>CP</b>	<b>SC</b>	<b>MB</b>
9854	39854	49854	59854



### Spring

For panic bolts

<b>PB</b>	9856
-----------	------

### 9855 - Saddles

For panic bolts

<b>PB</b>	<b>CP</b>	<b>SC</b>	<b>MB</b>
9855	39855	49855	59855



### Cylindrical Ferrule Keepers

10x10mm diameter

<b>CP</b>	39849
-----------	-------



### Barrel Bolt Raised Keeper

Specify particular bolt

<b>PB</b>	<b>ATQ</b>	<b>CP</b>	<b>SC</b>	<b>MB</b>
9854	29863	39863	49854	59854



### Flat Keeper

Specify particular bolt

<b>PB</b>	<b>ATQ</b>	<b>CP</b>	<b>SC</b>	<b>MB</b>
9850	29850	39850	49850	59850



# Flush Bolts



**Streamline Flush Mount Reverse Barrel Bolt**  
Wide Mount - 45mm bolt throw

100x32mm	<b>PB</b>	<b>ATQ</b>	<b>CP</b>	<b>SC</b>	<b>MB</b>
	5178	25178	35178	45178	55178
150x32mm	<b>PB</b>	<b>ATQ</b>	<b>CP</b>	<b>SC</b>	<b>MB</b>
	5179	25179	35179	45179	55179

**Slim Mount - 34mm bolt throw**

75x19mm	<b>PB</b>	<b>CP</b>	<b>SC</b>	<b>MB</b>
	5181	35181	45181	55181
150x19mm	<b>PB</b>	<b>CP</b>	<b>SC</b>	<b>MB</b>
	5180	35180	45180	55180

**Concealed Reverse Barrel**

12mm straight route rebate for easy installation  
Bolt is neatly boxed at rear  
Smooth Slide button operation

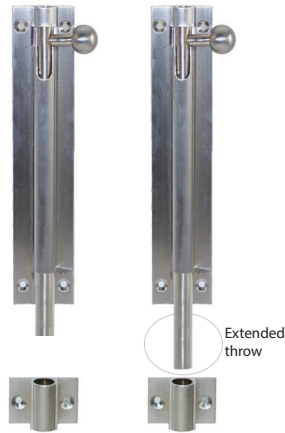

**Heavy Duty Barrel Bolt**  
25mm bolt throw

75x32mm	<b>PB</b>	<b>ATQ</b>	<b>CP</b>	<b>SC</b>	<b>MB</b>
	4267	24267	34267	44267	54267
100x32mm	<b>PB</b>	<b>ATQ</b>	<b>CP</b>	<b>SC</b>	<b>MB</b>
	4268	24268	34268	44268	54268
150x32mm	<b>PB</b>	<b>ATQ</b>	<b>CP</b>	<b>SC</b>	<b>MB</b>
	4269	24269	34269	44269	54269

**50mm extended bolt throw**

100x32mm	<b>PB</b>	<b>ATQ</b>	<b>CP</b>	<b>SC</b>	<b>MB</b>
	4263	24263	34263	44263	54263
150x32mm	<b>PB</b>	<b>ATQ</b>	<b>CP</b>	<b>SC</b>	<b>MB</b>
	4264	24264	34264	44264	54264
200x32mm	<b>PB</b>	<b>ATQ</b>	<b>CP</b>	<b>SC</b>	<b>MB</b>
	4264	24264	34264	44264	54264



**Heavy Duty Barrel Bolt - Offset Bolt**  
20mm bolt throw

100x32mm	<b>PB</b>	<b>ATQ</b>	<b>CP</b>	<b>SC</b>	<b>MB</b>
	4271	24271	34271	44271	54271
150x32mm	<b>PB</b>	<b>ATQ</b>	<b>CP</b>	<b>SC</b>	<b>MB</b>
	4272	24272	34272	44272	54272



**Easy Fix - Heavy Duty Flush Bolt**  
25mm bolt throw

150x19mm	<b>PB</b>	<b>ATQ</b>	<b>CP</b>	<b>SC</b>
	5182	25182	35182	45182
200x19mm	<b>PB</b>	<b>ATQ</b>	<b>CP</b>	<b>SC</b>
	5183	25183	35183	45183
450x22mm	<b>PB</b>	<b>CP</b>	<b>SC</b>	
	5185	35185	45185	

Reinforced guide behind bolt for additional strength  
Minimal rebate for installation  
Push button operation



**Standard All Purpose Flush Bolt**  
25mm bolt throw

150x19mm	<b>PB</b>	<b>CP</b>	<b>SC</b>
	5030	35030	45030
200x19mm	<b>PB</b>	<b>CP</b>	<b>SC</b>
	5031	35031	45031
Mini: 105x19mm	<b>PB</b>		
	5029		

Reinforced guide behind the face for additional strength



**Concealed Fixing Heavy Duty Flush Bolt**  
34mm bolt throw

150x19mm	<b>PB</b>	<b>ATQ</b>	<b>CP</b>	<b>SC</b>
	4444	24444	34444	44444
200x19mm	<b>PB</b>	<b>ATQ</b>	<b>CP</b>	<b>SC</b>
	4445	NA	34445	44445

Reinforced solid saddle for additional strength



# Door Stops Door Catches



# Door Stops



304  
STAINLESS STEEL

Includes expansion  
bolt & wood screw  
fixing options

- Black items are plated  
to order

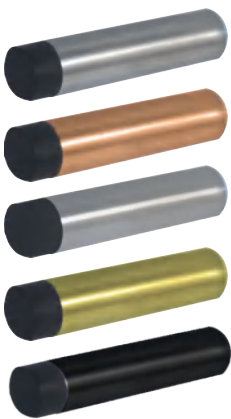

Wall Mounted

Round Tube

Length: 75mm / Diameter: 17mm

<b>PB</b>	<b>PSS</b>	<b>304 SSS</b>	<b>MB</b>	<b>COP</b>
13717	33717	43717	53717	63717



Wall Mounted

Square

Length: 85mm / Diameter: 22x22mm

<b>PVD</b>	<b>CP</b>	<b>SC</b>	<b>MB</b>
3711	33711	43711	53711



Floor Mounted

Flat Top

Height: 40mm / Dia: 30mm / Rubber 34mm

<b>PSS</b>	<b>304 SSS</b>	<b>MB*</b>
33714	43714	53714



Floor Mounted

Round Top

Height: 50mm / Dia.30mm / Rubber 40mm

<b>PSS</b>	<b>304 SSS</b>	<b>MB*</b>
33713	43713	53713



Floor Mounted

Square

Height: 45mm / 22x22mm

<b>PB</b>	<b>PSS</b>	<b>304 SSS</b>	<b>MB*</b>
3710	33710	43710	53710



Floor Mounted

Heavy Rubber 40mm

Height: 40mm / Diam. 30mm

<b>PB</b>	<b>PSS</b>	<b>304 SSS</b>	<b>MB*</b>
13715	33715	43715	53715

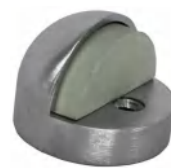

Floor Mounted

Half Moon Risen/Extended Base -12mm

Diameter: 45mm

<b>PB</b>	<b>PSS</b>	<b>304 SSS</b>	<b>MB*</b>
4302	34302	44302	54302



Floor Mounted

Half Moon

Diameter: 45mm

<b>PB</b>	<b>ATQ</b>	<b>PSS</b>	<b>304 SSS</b>	<b>MB</b>	<b>COP</b>	<b>SB</b>
3080	23080	33080	43080	53080	63080	93080



Floor Mounted

Square

Length: 40mm

<b>SC</b>	<b>MB</b>
43718	53718



Floor Mounted

Triangle

Diameter: 45mm

<b>CP</b>	<b>MB</b>
33728	53728

# Door Catch & Holding Mechanisms



**Door/Skirt Mounted Door Catch**  
Heavy Duty  
Catch: 55mm - projection  
Base: 65mm - projection

**PB** **CP** **SC**  
3320 33320 43320



**Door/Skirt & Floor Mounted Door Catch**  
Floor Mount Heavy Duty  
Catch: 32mm - projection  
Base: 25x25mm

**PB** **CP** **SC**  
3321 33321 43321



**Door/Skirt Mounted Door Catch**  
Heavy Duty  
Catch: 38mm - projection  
Base: 65mm - projection

**PB** **CP** **SC** **MB**  
3322 33322 43322 53322



**Magnetic Catch**  
Length: 45mm  
Width: 34mm

**SC**  
43727



**Magnetic Catch**  
Length: 53mm  
Width: 34mm

**PB** **CP** **SC**  
3722 33722 43722



**Magnetic Catch**  
Raised base for elevated catching height  
Length: 45mm Width: 38mm

**PB** **CP** **SC**  
3723 33723 43723



**Magnetic Catch**  
Square Design - Floor or Wall Mounted  
Height: 75mm  
Base: 48x48mm

**CP** **SC** **MB**  
33729 43729 53729



**Foot Operated Door Catch**  
Door Mounted  
Height/Width: 145x27mm  
Throw: 55mm

**CP** **SC**  
34099 44099



**Door Closer with Adjustable Closing Tension**  
Spring loaded - Modern concealed fix  
Height/Width: 115x30mm  
Recommended for internal doors

**SC**  
43730

5



# Numerals Alphabet Signage

# Numbers and Alphabet



316  
STAINLESS STEEL

0123456789

FONT: Arial Numbers 0-9

4891+[#0-9]	130mm	<u>316</u> <u>SSS</u>
4892+[#0-9]	150mm	<u>316</u> <u>SSS</u>
4893+[#0-9]	225mm	<u>316</u> <u>SSS</u>

0123456789

FONT: Arial Numbers 0-9

3891+[#0-9]	130mm	<u>PSS</u>
3892+[#0-9]	150mm	<u>PSS</u>

0123456789

FONT: Arial Numbers 0-9

5891+[#0-9]	130mm	<u>MB</u>
5892+[#0-9]	150mm	<u>MB</u>
5893+[#0-9]	225mm	<u>MB</u>

ABCDEFGHIJKLM  
NOPQRSTUVWXYZ

FONT: Arial Letters A-Z

48104+[A-Z]	150mm	<u>304</u> <u>SSS</u>
-------------	-------	--------------------------

ABCDEFGHIJKLM  
NOPQRSTUVWXYZ

FONT: Arial Letters A-Z

58104+[A-Z]	150mm	<u>MB</u>
-------------	-------	-----------

abcd abcd abcd

FONT: Arial Letters - 55mm

48100 = a	<u>304</u> <u>SSS</u>	48101 = b	<u>304</u> <u>SSS</u>
48102 = c	<u>304</u> <u>SSS</u>	48103 = d	<u>304</u> <u>SSS</u>

FONT: Arial Letters - 55mm

38100 = a	<u>PSS</u>	38101 = b	<u>PSS</u>
38102 = c	<u>PSS</u>	38103 = d	<u>PSS</u>

FONT: Arial Letters - 55mm

58100 = a	<u>MB</u>	58101 = b	<u>MB</u>
58102 = c	<u>MB</u>	58103 = d	<u>MB</u>



# Bathroom Door Signage



Acrylic black bathroom signage.

150mm Height

Male | Female | Disable

Includes aligning template. (glue no included)

**MB** 58130 1 Set includes three figures



FONT: Times New Roman Alphabet A-Z

3064+[A-Z] 75mm **PB**

3065+[A-Z] 150mm **PB**



FONT: Times New Roman Alphabet A-Z

33064+[A-Z] 75mm **CP**

33065+[A-Z] 150mm **CP**



Numbers 0-9

1881+[#0-9] 25mm **PVD**

1882+[#0-9] 50mm **PVD**

1883+[#0-9] 75mm **PVD**

1884+[#0-9] 100mm **PVD**

1885+[#0-9] 150mm **PVD**



Numbers 0-9

3882+[#0-9] 50mm **PSS**

3883+[#0-9] 75mm **PSS**

3884+[#0-9] 100mm **PSS**

3885+[#0-9] 150mm **PSS**



Numbers 0-9

1887+[#0-9] 75mm **PVD**

1888+[#0-9] 100mm **PVD**



Numbers 0-9

3887+[#0-9] 75mm **PSS**

3887+[#0-9] 100mm **PSS**

# myLOCK

Timber & Aluminium Doors

## Practical, Multi-Functional Living

### Lock Features:



### Lever Features:



Notes:



---

---

---

---

---

---

---

---

---

---

---

---

---

---

---

---

---

---

---

---

---

---

---



Quality is never an accident; it's the result of intention, innovation & skillful execution.

Opening Doors in auSTYLE

P +61 3 9553 3559

E [info@austyle.com.au](mailto:info@austyle.com.au)



[superioraustyle](#)



[austyle architectural hardware](#)

[www.austyle.com.au](http://www.austyle.com.au)

Service Supply & Support Since 1982

