



Download the
Sylvan Smart App

Scan the QR Code to get started!

SL36E

INSTALLATION INSTRUCTIONS



Thank you for choosing Sylvan, this lock is for Residential use only, and its two warranty (mechanical and electronic) only applies for locks being used for residential use.

To ensure you get the best out of your purchase we ask that you follow the below:

- Please read these instructions fully before installation of this lock.
- We recommend this lock is installed by a professional installer or a serious DIYer to ensure correct installation and operation.
- The supplied rubber boots must be installed; however, this smart lock requires a smooth flat surface to hold its water tightness. This lock is not suitable for use on a tongue and groove door, where water can penetrate the lock via a groove in the door.
- We recommend that this lock is never fully exposed to direct weather for long periods of time. For long lasting properties of the product, positioning the lock under a eave or sheltered position is best.
- This lock is rated IP55, but only on the outward face of the lock. No warranty is given if the lock gets damaged from water for the inside of the door.
- This lock is not suitable for use on a gate.
- This lock comes with a mechanical key override, this can be used in a situation of complete battery loss. We recommend an override key is put somewhere safe outside in case complete power loss.
- Replace batteries when they are showing low voltage on the app.
- All batteries used with this lock must be high quality Alkaline (4 x AA batteries), to ensure long lasting use.
- Lithium or rechargeable batteries cannot be used with this lock.



Installation Video

Scan this code:











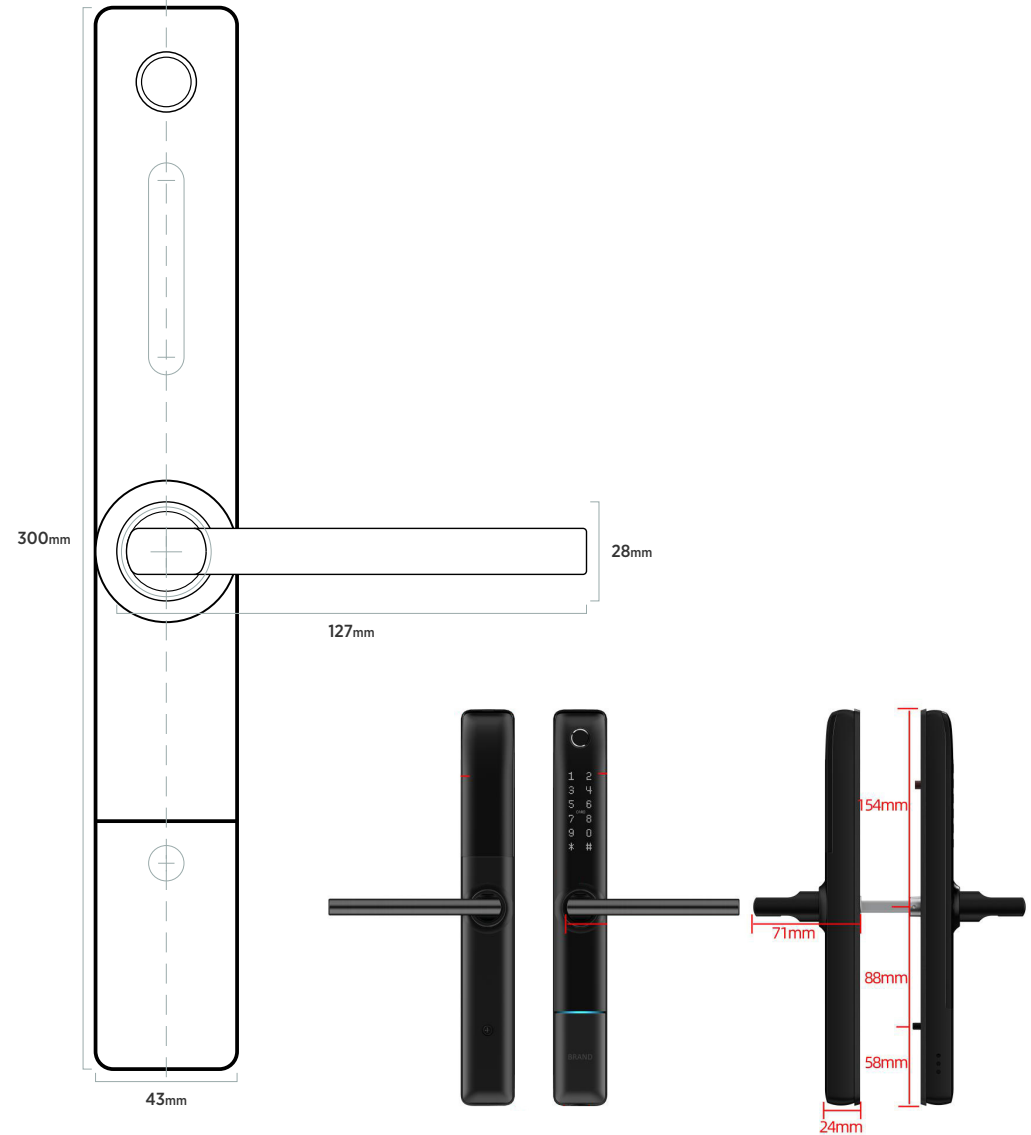



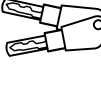

App Setup Video

Scan this code:

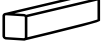

If you prefer not using an app for programming your smart lock, most functions can be setup manually using the instructions here:

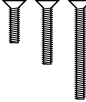
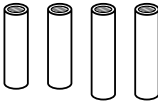

- 
 - **Front panel**
Qty x1
- 
 - **Back panel**
Qty x1
- 
 - **User manual**
Qty x1
- 
 - **Installation template**
Qty x1 **RFID Tag**
Qty x2
- 
 - **Self adhesive disc**
Qty x2
- 
 - **Mechanical keys**
Qty x 2
- 
 - **Waterproof rubber boot**
Qty x2
- 
 - **Allen key 4mm**
Qty x1
- 
 - **M5 thread locked screw**
Qty x2
- 
 - **Wood screws**
25x4mm - Qty x4
- 
 - **Aluminium fixing screws**
M5x 10mm Qty x4
- 
 - **Short spindle 60mm**
Qty x1 (for narrow doors
35mm - 50mm)
- 
 - **Long Spindle 80mm**
Qty x1 (for wider doors
50-70mm)
- 
 - **Sliding T slot screw**
M5x 16mm Qty x2
- 
 - **Various M5 machine screws**
Qty x1
(25mm , 30mm, 40mm,
50mm, 60mm 70mm)
- 
 - **Connection posts**
M5x 30mm Qty x2
M5x 30mm Qty x2
- 
 - **Smart hub**
Qty x1 (optional)

Model number	SL36E	Door thickness range	35mm - 70mm
Material of Manufacture	Aluminum alloy	IP rating	IP55
Weight	2.5 kg	Type of use	Residential use only
Options of unlocking	Blue tooth Finger print Passcode Card Mechanical key Gateway (optional) Disc (optional)	Passcode capacity	App unlocks infinite Fingerprints: 200 max Passcodes: 150 max RFID Cards: 200 max
Working temperature	-10 - + 55 degrees C	Working Humidity	0-95%
Normal voltage	6 volts (4 x Alkaline batteries)	Warranty	2 years mechanical
			2 years electronic
Low voltage Alarm	Less than 4.8 Volts	Lock	Stainless steel body
Lever handing	Reversible	Mortice Latch bolt	Reversible

Anti Peeping Technology

This lock offers anti-peeping virtual passcode entry by inputting a random passcode either before or after the proper passcode followed by the # key.

Installation: Mortice Lock

Optional: Check handing of the mortice lock Below are the instructions to change handing if required.

Step 1:

Flip lock body upside down

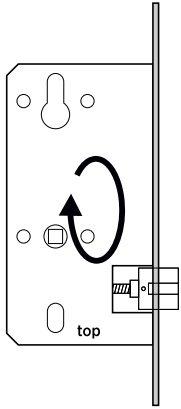

Step 2:

Depress latch mechanism into lock body

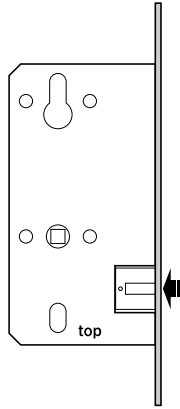

Step 3:

Rotate latch mechanism

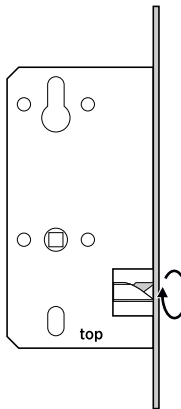

Step 4:

Align and release latch mechanism,

▲ IMPORTANT
Make sure to correctly align the center latch otherwise the lock will not function correctly.

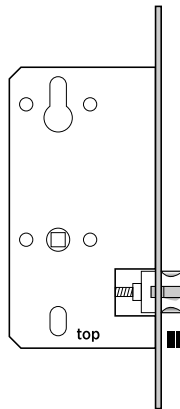

Install Mortice (see mortice lock instructions included)

1. Mark and crop door using installation template provided
2. Ensure holes are clear of any sharp edges and clean of swarf and wood dust.
3. Adjust tongue of latch depending on the way the door operates (refer to page 6)

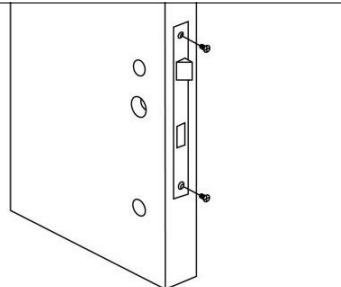

Installation: Handing

Check handing of the lever

Below are the instructions to change handing.

Front (outside) Panel

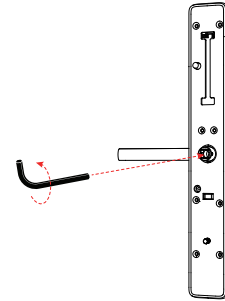

1. Using an allen key, remove screws from the inside of the handle

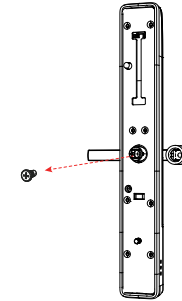

2. Remove and rotate the handle to the left or right depending on handing direction.

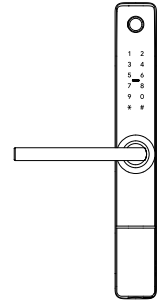

3. Reinsert the screws (using new screws provided) after adjusting handing direction

Back (inside) Panel

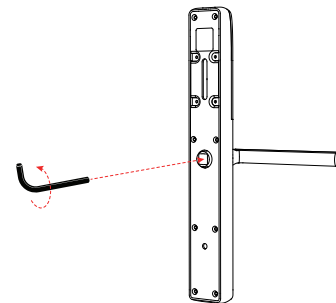

1. Using an allen key, remove screws from the inside of the handle

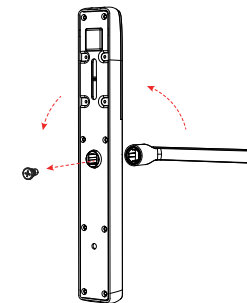

2. Remove and rotate the handle to the left or right depending on handing direction.

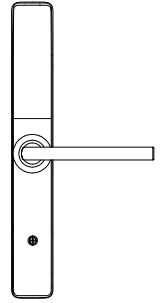

3. Reinsert the screws (using new screws provided) after adjusting handing direction

⚠ CRITICAL WARNING: POWER CABLE MANAGEMENT

The power cable is the most delicate part of your lock. Do not pinch, crimp, or crush the cable during installation. Ensure it sits in a clear “pocket” within the door cavity.

Note: Any damage to the cable caused by improper handling during installation will void your warranty.

Step 1: Install Outside Lock Panel

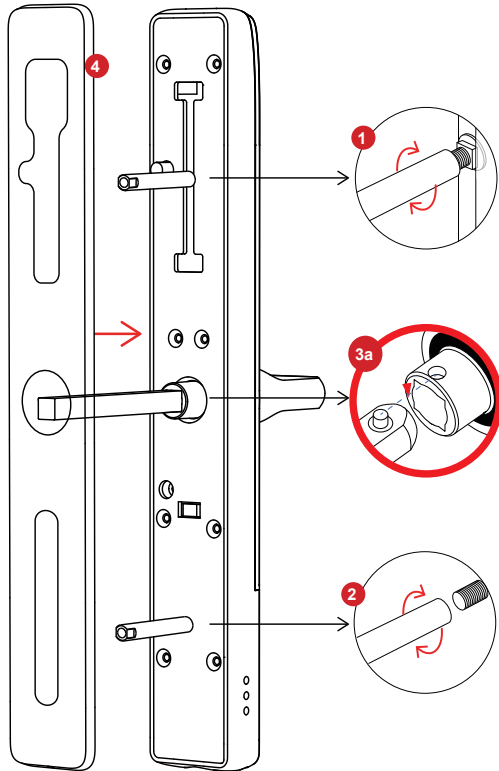

1. Install T Slot Screw:

- Insert the T slot screw into the top slot.
- Loosely attach the correct length of M5 posts to the T slot screw
- Adjust to align with the holes drilled through the door.
- Tighten using an adjustable spanner

2. Attach bottom M5 Posts:

- Attach the correct length of M5 post to the bottom threaded stud on the bottom of the panel.
- Tighten using an adjustable spanner

3. Select Spindle: Choose the correct length based on your door thickness:

- 35mm – 48mm door:**
Use the 60mm spindle.
- 48mm – 65mm door:**
Use the 80mm spindle.

3a. Secure Spindle:

- Clip the spindle into the assembly.
- Crucial: Ensure the indicator arrow is pointing the same direction as the handle.**

4. Install Rubber Boots:

- Install rubber boots on the outside and inside panels, ensuring they fit correctly into each receiving holes on the back face of each panel. Note: these only fit correctly one way. The boot will sit flat and snugly if installed correctly.

5. Feed Outside Panel:

- Feed the outside panel into the door's mounted mortice lock, aligning the spindle and posts through the lock and pre-drilled holes in the door.

⚠ IMPORTANT: When feeding the power cable through the door, ensure adequate space to prevent the cable from being crushed, damaged, or cut during installation.

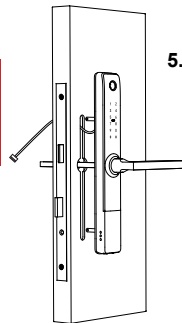

⚠ IMPORTANT

Ensure the indicator on the spindle hub of the lock is pointing the same direction as the handle

Handle Direction



Installation: Smart Lock

Step 3: Install Inside Lock Panel

1. Remove Battery Cover:

- Carefully remove the battery cover from the inside panel.
- Feed through enough cable to plug the outside handle to the inside handle receiving plug once fully installed on the door.

2. Attach Fixing Screws:

- Use the correct length of fixing screws to align the lock to the door.
- Ensure the lock fits completely flat against the door.
- Ensure the rubber boots are fully sealed on both the inside and outside of the door, and that the panel is correctly aligned vertically.

3. Connect Cable: Remove the battery cover. Carefully plug the power cable into the receiver.

Tip: The plug only fits one way—don't force it!



Manage Excess Cable: Tuck any extra cable length back into the door cavity to prevent it from being pinched between the panel and the door.

4. Install Batteries:

- Insert 4 alkaline batteries (we recommend Energizer Max batteries).

5. Reattach Battery Cover:

- Ensure the cable is free from obstructions when reattaching the battery cover.

⚠ IMPORTANT

Pinching, crimping or crushing the power cable may break the internal connection, and void the lock warranty.

Step 4: Install Striker Plate and Test Lock Operation

1. Fit Striker box and striker Plate:

- Fit the striker box and the stiker plate into the door frame, ensuring the latch and bolt work freely when the door is closed.
- For aluminum-framed doors, use Sylvan's accessory plastic packer (see Sylvan Smart Lock Striker Packers).

2. Test Deadbolt Operation:

- Close the door and test the mortice lock by lifting the inside handle. Ensure the lock runs freely into the striker plate without resistance.
- If binding occurs, adjust the striker plate for proper alignment.
- Installation Complete: To set up the lock on a smartphone, refer to the TTlock app setup instructions in this booklet.

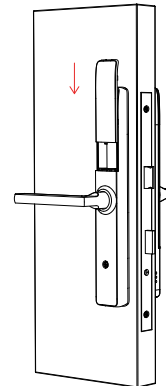
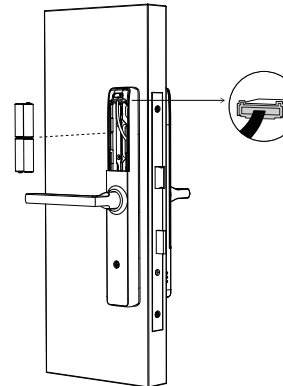
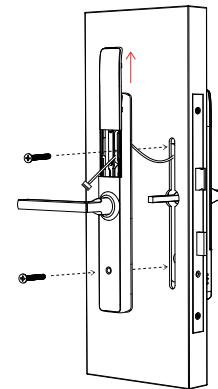

Lock Installation Checklist

1. Holes drilled and aligned as per drilling template.
2. Arrow on spindle hub points towards the handle.
3. Ensure the rubber boot is aligned correctly with a good seal on the door, also making sure the lugs are correctly seated in their holes .
4. Ensure all screws and bolts are correctly tightened.
5. Ensure power cable is installed and not bent or crimped in door.
6. Check batteries are Alkaline and installed correctly.
7. Check to see if the lock requires a software update via the TT App

1. Date Installed: _____ / _____ / _____
2. Installed By: _____
3. Pin: # _____

Manual reset:

If you are not admin of the Smart Lock, remove battery cover and complete:

Long press the reset button beneath the battery case for 5 seconds or until you hear: "Please Input Initialisation Passcode".

Now input code "000#" on the keypad.

The system reset will be complete. From here you can re-link the SL36E Smart Lock to your phone via the TT App.

**Note: this will clear all previous users from the locks memory*

IMPORTANT
Ensure the indicator on the spindle hub of the lock is pointing the same direction as the handle



TOP

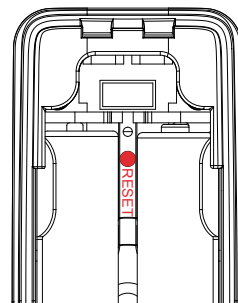

Using your Sylvan SL36E Smart Lock

Your Sylvan SL36E has two handle functions:

Lift up the handle to engage the mortice deadbolt.

Pull down to unlock and release latch + deadbolt

Important Notes: When the smart lock automatically locks, the handle disengages from the latch, but you can still lift the handle to engage the mortice bolt.

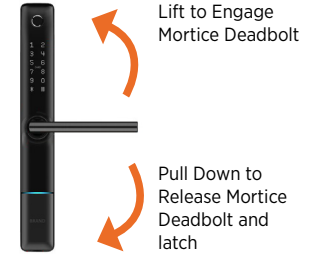

Manually unlocking with Key

The SL36E Smart Lock has a mechanical key override to unlock it. The lock location is under the front panel.

Insert one of the included keys, turn and pull handle down to unlock.

Shown is the location of the mechanical key barrel, The Micro USB port beside it can be used to power up the Smart Lock if the batteries fail. When connected to a power bank or battery source, the Smart Lock can be powered up and then a PIN Code, RFID Card or the app can be used to unlock it.



Maintenance Guide:

Maintenance should be carried out on your lock every 6 months:

- If the accuracy of the fingerprint reader decreases, please replace batteries.
- Check that the screws fixing the mortice Lock are tight. Check that the screws fixing the rear panel to the front panel are tight. Check that the inner retaining cap screws that hold the handle onto the backplate are tightened. If the handles start to work themselves loose these need to be tightened up using a thread lock to prevent them from loosening again.
- Check if batteries need replacing. If battery percentage is low replace with four fresh Alkaline 1.5V AA batteries.
- Wipe the surface of the Lock with a damp cloth, we recommend only water is used. This will help remove any dust or micro contaminants from the surface.
- It is also recommended to do a full factory reset of the Smart Lock to ensure software runs correctly.
- Check rubber boot to ensure the seal between lock and door is still good.



Smart Hub*

**UNLOCK
YOUR DOOR
ANYWHERE****



*sold separately **depending on structure and signal interference.

Sylvan Smart App Set-up instructions:

1. Download the Sylvan Smart App

Apple (IOS version) use app store to download Sylvan Smart

Android version go through Google Play to download Sylvan Smart

Or alternatively scan the QR Code below



Sylvan Smart App

- Sylvan Smart supports multiple types of locks and devices
- Verification codes will be sent to users' mobile phone or email depending on how you have registered above.

Account setup and add locks

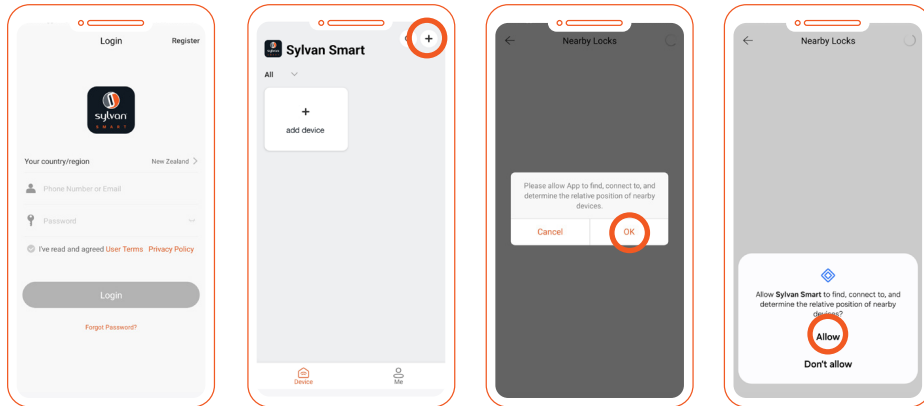

1. Register a new account (phone number or email) OR if you have an existing account login using your current account details
2. With App open touch on home screen select + / Add lock
3. While standing near the lock (and with the 4 good quality AA alkaline batteries installed into the lock) wake the lock up by touching the keypad.

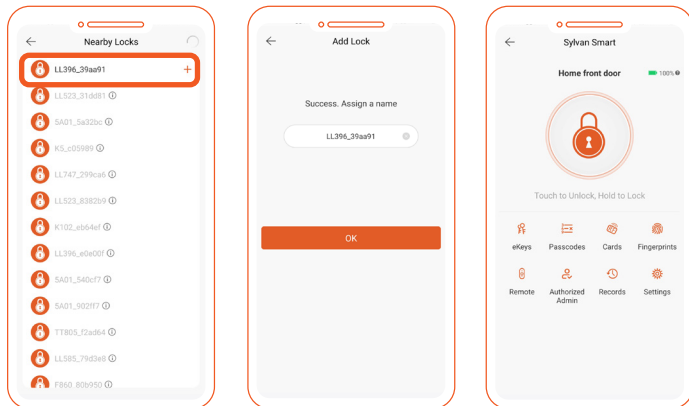

4. Your lock will appear on the screen, then select +
5. Rename the lock. e.g. home front door
6. The lock is now successfully added to the Sylvan Smart app.

Bluetooth (lock and unlock)

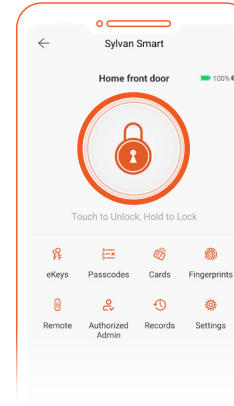

1. Make sure your phone has Bluetooth and Bluetooth is switched on.
2. The app can be used to lock or unlock the door by using Bluetooth within a 5m range.
3. From the app press the (padlock) symbol to lock or unlock the device.

NOTE

- The lock will automatically re lock itself depending on the setup of the auto lock function through the app.
- 5-meter Bluetooth range can vary depending on interference such as steel, thick walls and microwave interference etc.

RFID cards

This lock comes with three RFID cards and can store up to 200 unique RFID cards.

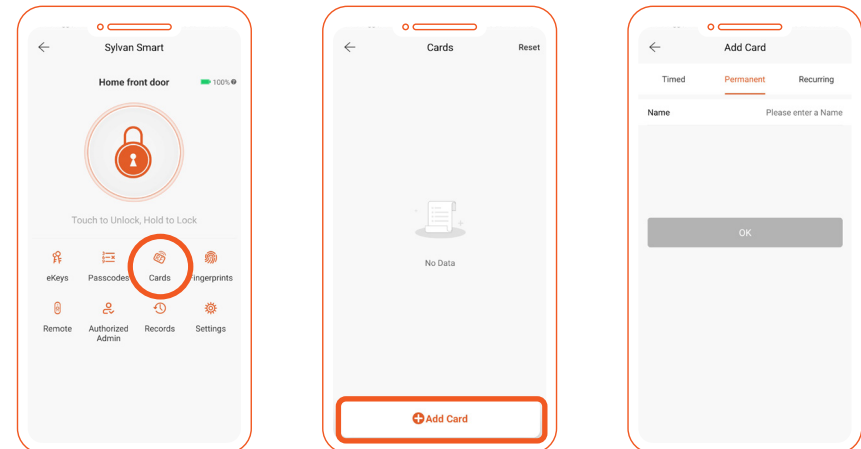

1. To add these to the lock, select Cards
2. Add card
2. Select Permanent, Timed or Recurring user
3. Name the Card (we suggest the users name) e.g. Bobs RFID, press ok.
4. Then touch card against lock keypad to accept card to lock

3. Management of app and lock

Setting a passcode:

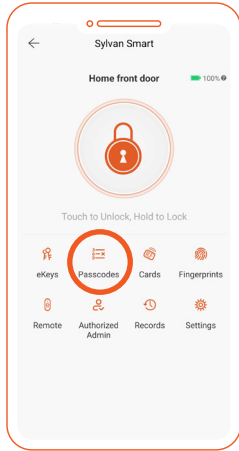

1. Open the Sylvan Smart App
2. Select your lock
3. Press Passcodes

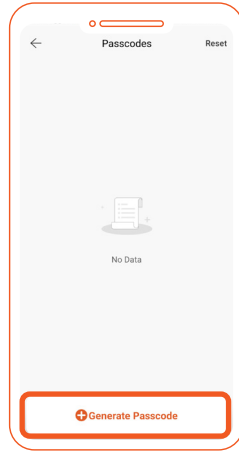

4. Generate Passcode

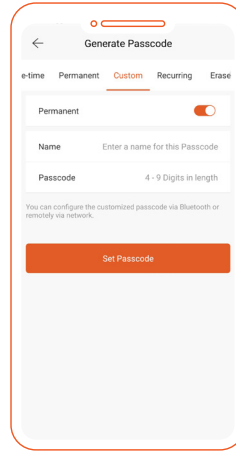

5. As suggested in the notes below Press "custom"
6. Ensure Permanent is switched for all time access
7. Enter a name for the passcode eg Bob's code
8. Enter the 4–9-digit passcode then # or ✓ depending on the model (refer above)
9. Press Set passcode

Helpful hints when setting up passcodes:

- Careful consideration should be taken to ensure each PIN is set up in a way that they can be managed later. We suggest naming each PIN with the name of the person using it. E.g. Bobs PIN
- When setting up passcodes use the 'custom' setting to create your own pin number. It needs to be between 4-9 digits followed by '#' or '✓' e.g. 1234#.
- Recurring PIN codes are used to give access to the user of this code at certain times of the day and week.
- Codes can also be created for "One time" access (for example a tradesperson working in your house for a short period of time).

Fingerprint Access: (only applicable if your lock has this feature)

This lock can accept up to 200 Unique fingerprints

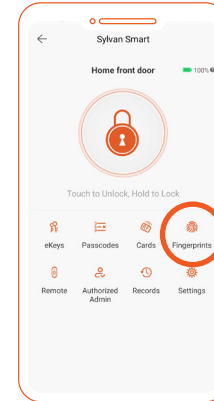

1. From your locks main screen select Fingerprints

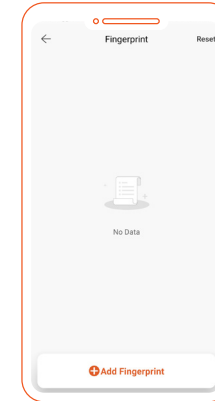

2. Then add fingerprint

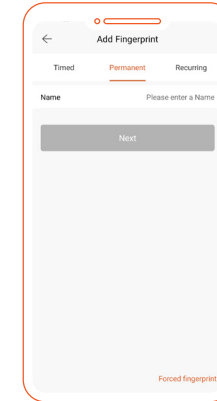

3. Decide if a Permanent, Timed or Recurring user
4. Name the fingerprint (we suggest the users name) eg Bobs Finger

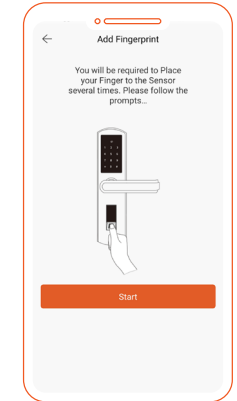

5. The app then prompts you to present your finger or thumb to the reader.

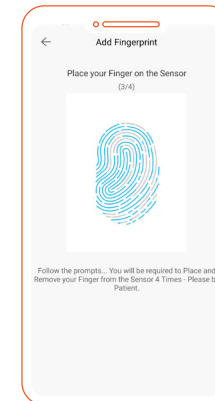
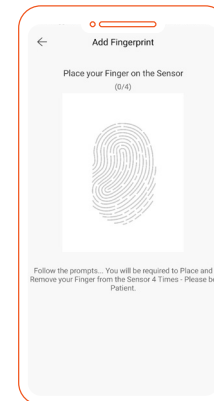

6. Watch and listen to the prompt of the app and lock you will see the image of the fingerprint and be asked to present your finger to the reader.
7. You will be asked to do this several times until all parts of the image on the app turn from black to orange.

Note:

We suggest for convenience and user speed to save your fingerprint in several different positions. EG Bobs 1 finger, Bobs 2 finger etc.

3. Management of app and lock

Passage mode

The Sylvan Smart app can be used to put the lock into passage mode.

Note: Passage mode is where the lock can be opened without requiring the passcode to be entered.

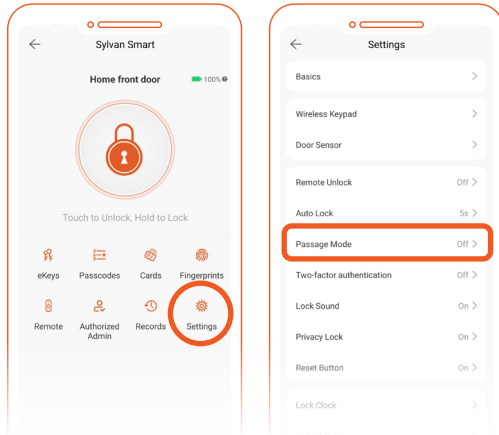

1. Under the setting tab of the lock, you can switch passage mode on or off
2. You can also set up a calendar so that the lock can go into passage mode on certain days at certain times.
3. Note for security reasons the passage mode only starts once a successful entry to unlock the lock has been accepted.

To lock the door when in passage mode, press and hold the # key on the lock.

Scheduled Passage Mode

Scheduled Passage Mode keeps the lock unlocked during the times you specify.

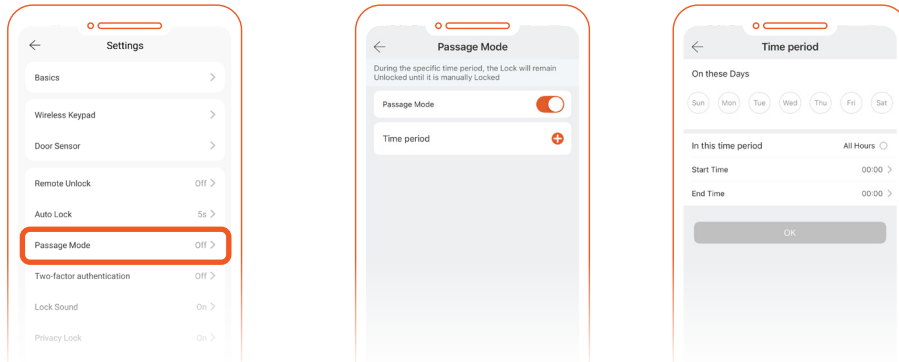

- Go to Settings > Passage Mode.
- Choose the days and hours you want the lock to remain open, for example Monday to Friday, 9:00 to 17:00.
- When unlocked electronically during these hours, the lock will remain in the unlocked state.
- If Auto Lock is enabled, the lock will secure itself again at the scheduled time.

Enable Manual Passage Mode

You can enable Passage Mode manually by unlocking the Sylvan Smart using a PIN or another valid method, then entering 123# or ✓ on the keypad.

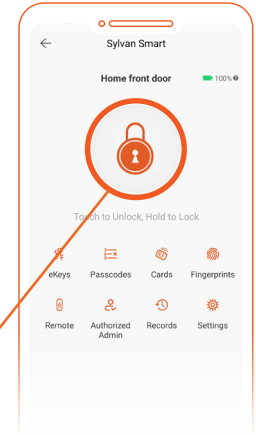

Lock the Door While in Passage Mode

- **Option 1:** Open the Sylvan Smart App, then press and hold the **Lock** button. Lift the handle to engage the deadbolt.
- **Option 2:** To exit Passage Mode from the keypad, press and hold the # or ✓ key, then lift the handle to engage the bolt.

Privacy mode

Some Sylvan locks have a secure lock function (SL37, SL39) the button is underneath (SL38, SL40, SL41) the button is on the back face of the lock.

When the secure lock feature is turned on (Red is showing on the SL38/SL40/SL41) only the key override or master admin code can be used to unlock the lock. If this function is turned off (showing Green) the lock is in normal mode.

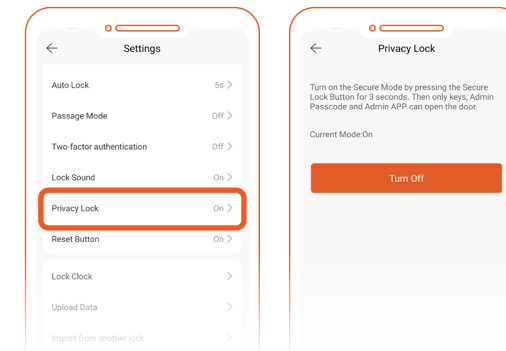

1. Under the setting tab of the lock, you can switch privacy mode on or off, By switching the turn off feature, this will disable the button on your lock.

3. Management of app and lock



Remote unlock

This can be done using a smart hub SLG02 (sold separately) see www.sylvan.co.nz/smart-hub-slg02

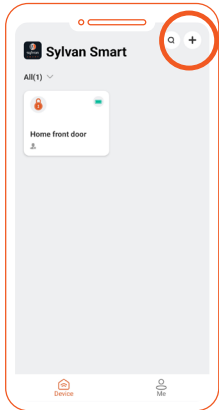

1. Add the smart hub via the home screen of the app
2. Ensure the gateway is within 10 meters of the lock and unplugged
3. Click on + / add new device

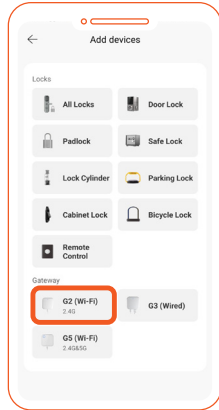

4. Choose the G2 (Wi-Fi) option under Gateway

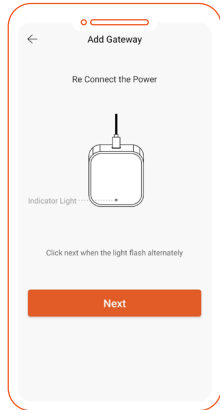

5. Connect power to the gateway and the indicator light will flash red, it's now in programming mode
6. Click next

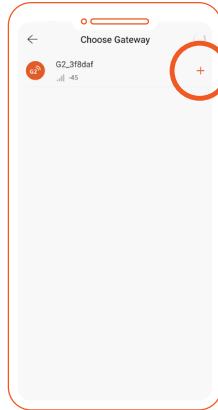

7. Your gateway will appear on the screen, then select +

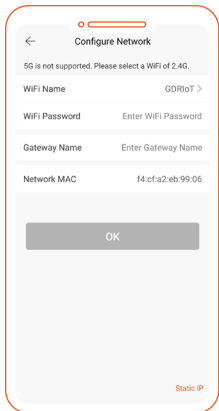

7. **Configure network:**
The app will ask you to select your WiFi network and password (**Important this needs to be a 2.4G** signal. 5G is not supported).

Ensure your smart phone is connected to the 2.4G signal whilst connecting to the gateway

Once seen it will ask for you to name the gateway e.g. (garage door gate way)

Once complete, select OK

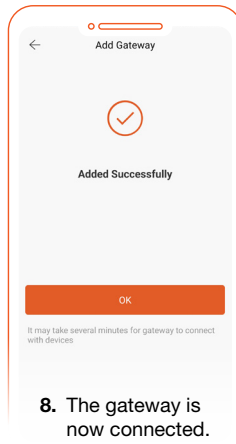

8. The gateway is now connected.

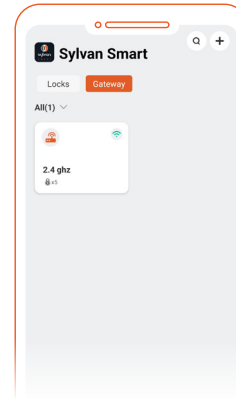

9. Check that the gateway is online under the gateway link on the front page of the App

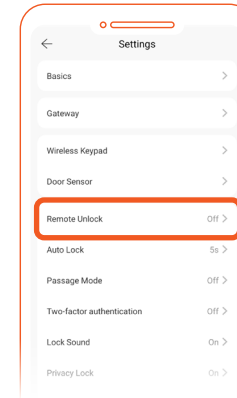

10. Return to the setting screen of your lock and click on gateway and you should see your named gateway.

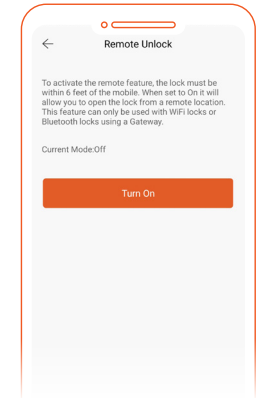

11. On the settings page select 'Turn On'

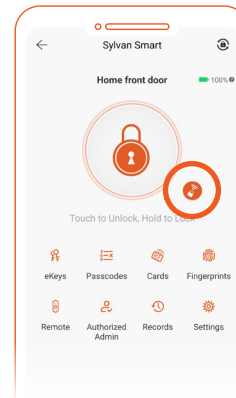

12. On the main programming screen of the lock a small WiFi/Padlock symbol will now appear next to the padlock symbol of the app.

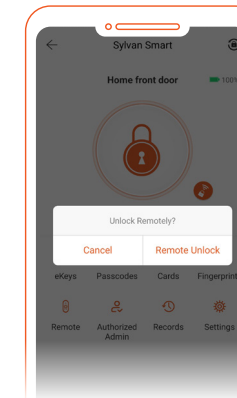

13. By clicking on the WiFi/Padlock symbol, then clicking Remote unlock you will be able to remotely unlock your lock from anywhere using the secure Wi Fi connection.

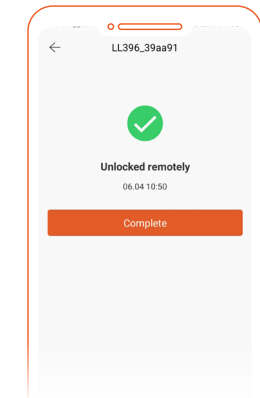

14. The app will show when the lock has been successfully unlocked.

Power and Time Settings

Check Battery Percentage

Use the Sylvan Smart App to check the battery level of your Sylvan Smart lock.

- On the lock selection page, the app shows an overview rounded to the nearest 5%.
- For a more precise reading, go to **Settings > Basics**.
- To refresh the reading, select **Battery** and then **Update** while you are within Bluetooth range of the lock.

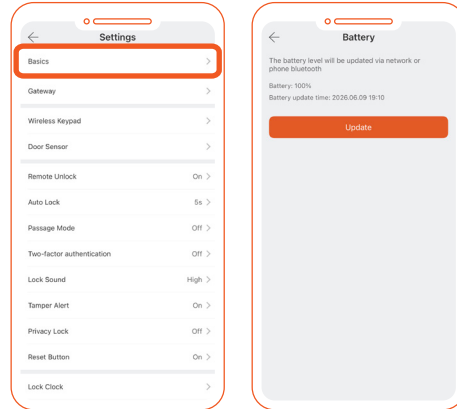

Calibrate the Lockset Clock

- Open **Settings > Lock Clock**.
- Select Calibrate Time.
- Your Sylvan Smart lock will sync with the app and set the correct time.
- This helps keep operating schedules and unlock records accurate.

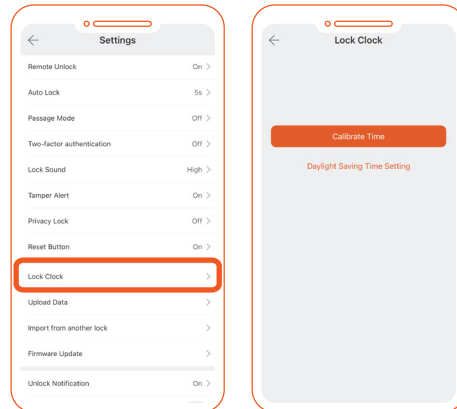

Authorised Admin

An Authorised Admin can access your Sylvan Smart using their own Sylvan Smart App.

- They can add, change, or delete unlock codes that they create themselves.
- To set this up, go to **Authorised Admin** on the lock management home page, then select **Create Admin**.
- Send the invitation to the phone number or email address linked to the recipient's Sylvan Smart App account.

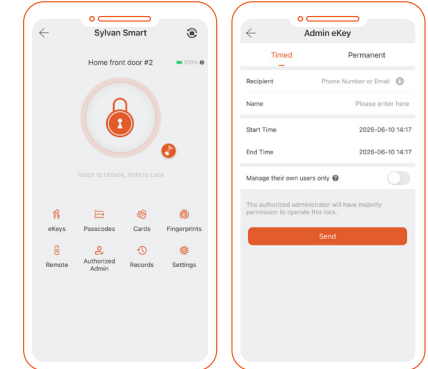

e-Key Management

An e-Key allows another person to lock or unlock your Sylvan Smart lock through the Sylvan Smart App.

- e-Keys can be permanent or set with specific time or access parameters.
- On the lock management page, select **e Keys**, then choose **Send e Key**.
- Send the e-Key to the phone number or email address linked to the recipient's Sylvan Smart App account.

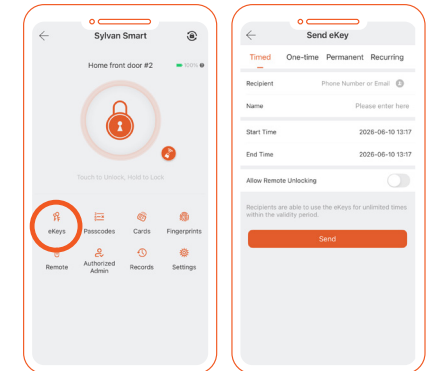

Transfer Ownership

The **Master Admin** can transfer ownership of a lock to another Sylvan Smart App account holder, including saved settings and PINs.

- Open the app menu, then go to **Settings > Transfer Lock**.
- Select the lock you want to transfer.
- Enter the recipient's phone number or email address associated with their Sylvan Smart App account, then select **Next**.

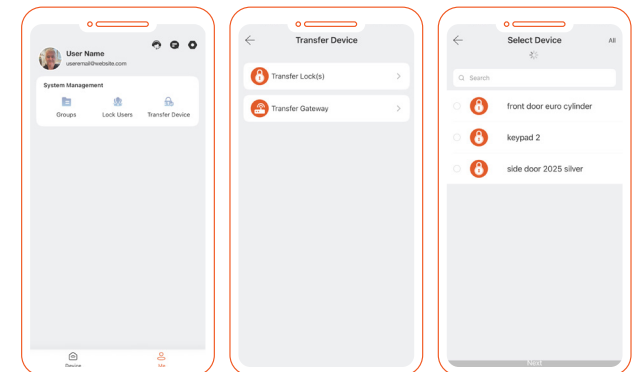

4. Additional Settings

Security and Access Records

Admin Passcode

Each Sylvan Smart lock comes with an admin passcode.

- To view it, go to **Settings** on the lock management page, then select **Basics > Admin Passcode**.

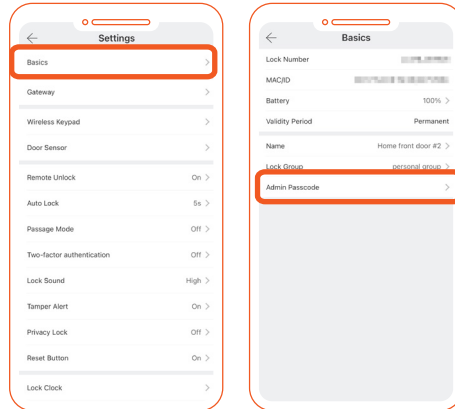

Lock Behaviour and Sound

Auto Lock

Auto Lock automatically disengages the exterior handle after a set period.

- In the app, go to **Settings > Auto Lock**.
- Adjust the timer or turn the feature off as needed.
- If Auto Lock is turned off, Passage Mode will not relock automatically.

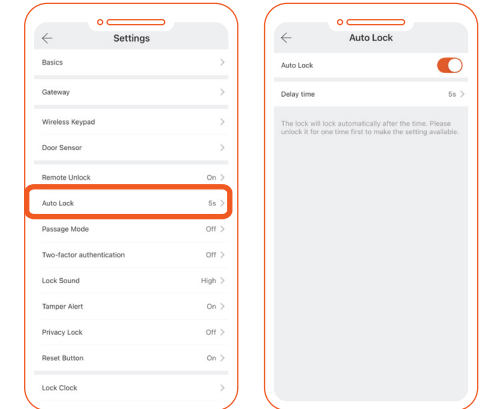

Unlock Records

The Sylvan Smart App records which passcodes were used to lock or unlock the Sylvan Smart and when they were used.

- To view these records, open the **Records** menu on the lock management page.
- Only a limited period of records can be stored in the app.
- You can export records to a spreadsheet for long-term storage, then clear or refresh the app records to keep them current.

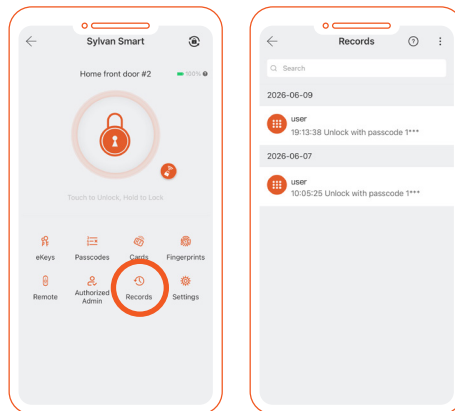

Lock Sound

Use Lock Sound to enable or disable audio feedback and to control the volume.

- By default, Lock Sound is enabled and set to high.
- Go to **Settings > Lock Sound** to change the setting.

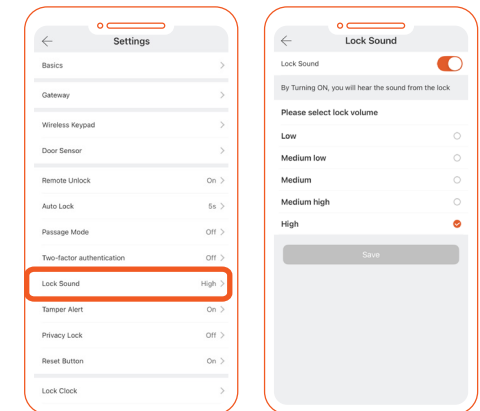

4. Additional Settings

Lock Sync and Grouping

Import from Another Lock

This feature lets you sync PIN codes and RFID cards between Sylvan Smart locks.

- Go to **Settings** > **Import from another lock**.
- Select the lock you want to import from.

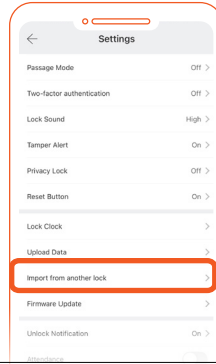

Lock Groups

Lock Groups let you organise multiple Sylvan Smart locks together, such as locks at the same site.

- First create a lock group in the main settings.
- Then, in each individual lock, go to **Settings** > **Basics** > **Lock Group** and assign the lock to the group.
- You can view lock groups from the lock selection page to keep the app home screen tidy.

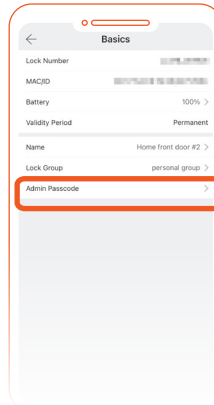
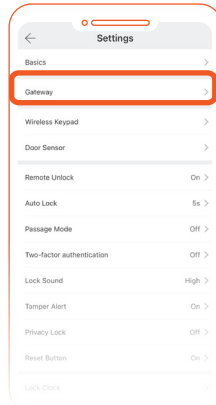

Reset Button Control

You can disable the manual reset button by turning off Reset Button in the Sylvan Smart App settings.

- Go to **Settings** > **Reset Button** and adjust the setting to suit your needs.
- This can be especially useful for Airbnb properties, rentals, or other shared-use installations.
- When the reset button is disabled, only the **Master Admin** can factory reset the lock.

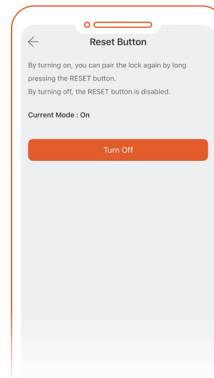
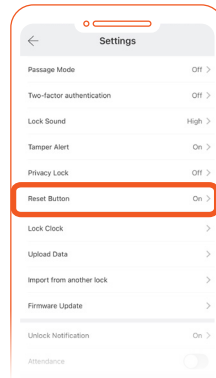

Factory Reset

- Via the Sylvan Smart App (Master Admin only): On the lock management page and within Bluetooth range, go to **Settings** > **Delete**, then enter your app password. The lock will then be factory reset.
- **Manual reset:** Remove the battery cover and hold the reset button in the battery compartment until you hear, “Please input initialization passcode.” Enter 000# on the keypad. The lock will then announce, “Deleting administrator successful.”
- If the **Reset Button** feature has been disabled, manual reset will not be available.

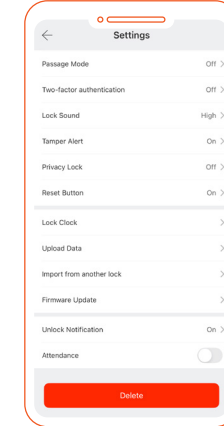

Remove Reset or Replaced Locks from the App

- To remove a reset or replaced lock from the Sylvan Smart App, open the app menu and go to **Settings**. Select **Transfer Lock(s)**, choose the lock, select **Next**, then choose **Remove the damaged device** at the bottom of the page.

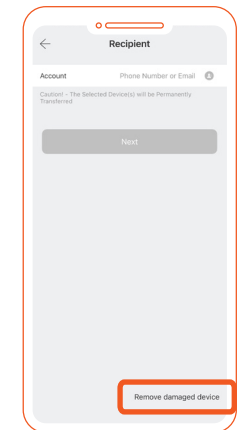
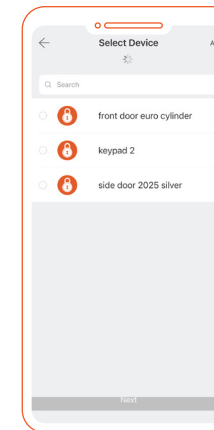
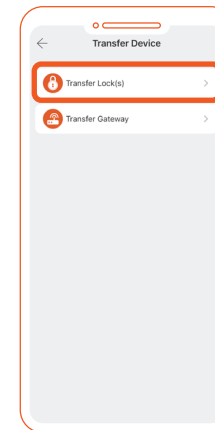
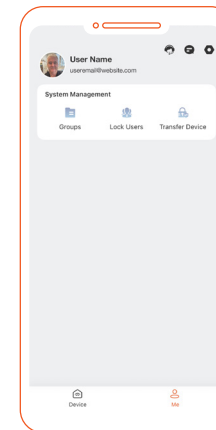



PRODUCT WARRANTY

Customer Name: _____

Customer Phone: _____

Purchase Date: _____

Store name: _____

Receipt #: _____

Product Name: _____

Product Model: _____

Note: _____

Note:

1. Please keep this card so that you can use it when you need warranty service.
2. We provide you with a two-year warranty from the date of purchase.

GDRutter
LIMITED

127 Diana Drive
Glenfield
Auckland 0627
Ph: +64 9 444 5359
Email: sales@gdrutter.co.nz
Web: www.sylvan.co.nz