



SL37E

INSTALLATION INSTRUCTIONS



sylvan
WARRANTY*



Version 2



Introduction

Thank you for choosing Sylvan, this lock is for Residential use only, and its two year warranty (mechanical and electronic) only applies for locks being used for residential use.

To ensure you get the best out of your purchase we ask that you follow the below:

- Please read these instructions fully before installation of this lock.
- We recommend this lock is installed by a professional installer or a serious DIYer to ensure correct installation and operation.
- The supplied rubber boots must be installed; however, this smart lock requires a smooth flat surface to hold its water tightness. This lock is not suitable for use on a tongue and groove door, where water can penetrate the lock via a groove in the door.
- We recommend that this lock is never fully exposed to direct weather for long periods of time. For long lasting properties of the product, positioning the lock under a eave or sheltered position is best.
- This lock is rated IP55, but only on the outward face of the lock. No warranty is given if the lock gets damaged from water for the inside of the door.
- This lock is not suitable for use on a gate.
- This lock comes with a mechanical key override, this can be used in a situation of complete battery loss. We recommend an override key is put somewhere safe outside in case complete power loss.
- Replace batteries when they are showing low voltage on the app.
- All batteries used with this lock must be high quality Alkaline (4 x AA batteries), to ensure long lasting use.
- Lithium or rechargeable batteries cannot be used with this lock.



Installation Video

Scan this code:



App Setup Video

Scan this code:



Lock Dimensions

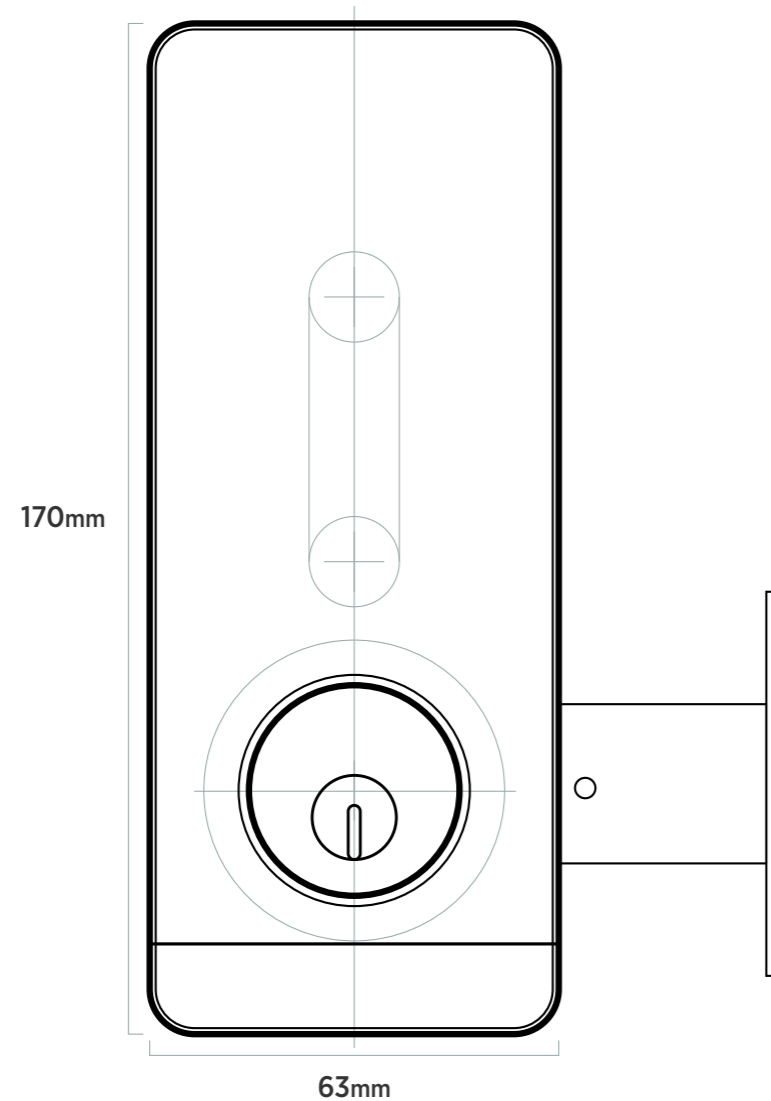



Product specifications:

Model number	SL37E	Door thickness range	35mm - 55mm
Material of Manufacture	Aluminum alloy	IP rating	IP55
Weight	2 kg	Type of use	Residential use only
Options of unlocking	Blue tooth Finger print Passcode Card Mechanical key Gateway (optional) Disc (optional)	Passcode capacity	App unlocks infinite Fingerprints: 200 max Passcodes: 150 max RFID Cards: 200 max
Working temperature	-10 - + 55 degrees C	Working Humidity	0-95%
Normal voltage	6 volts (4 x Alkaline batteries)	Warranty	2 years mechanical 2 years electronic
Low voltage Alarm	Less than 4.8 Volts	Lock	Stainless steel front

Anti Peeping Technology

This lock offers anti-peeping virtual passcode entry by inputting a random passcode either before or after the proper passcode followed by the # key.

SL37E Packing List

- | | | | |
|---|---|---|---|
|  | • Front panel
Qty x1 |  | • Mortice screws
Qty x4 25mm |
|  | • Back panel
Qty x1 |  | • Connection posts
Qty x1
(M4x30 - for 35-40mm Door thickness)
(M4x35 - for 40-60mm Door thickness) |
|  | • User manual
Qty x1 |  | • Various M6 machine screws
Qty x4
(30mm, 50mm) |
|  | • Installation template
Qty x1 |  | • Smart hub
Qty x1 (optional) |
|  | • Mortice lock / latch
Qty x1 |  | • Smart Disc
(optional) |
|  | • Striker plate
Qty x1 |  | • Backplate |
|  | • RFID cards
Qty x3 |  | • Backplate fixing M4 machine screws
Qty x4 (10mm) |
|  | • Mechanical keys
Qty x 2 | | |
|  | • Waterproof rubber boot
Qty x2 | | |
|  | • Striker Plate Box
Qty x1 | | |

Adjust Deadbolt Backset



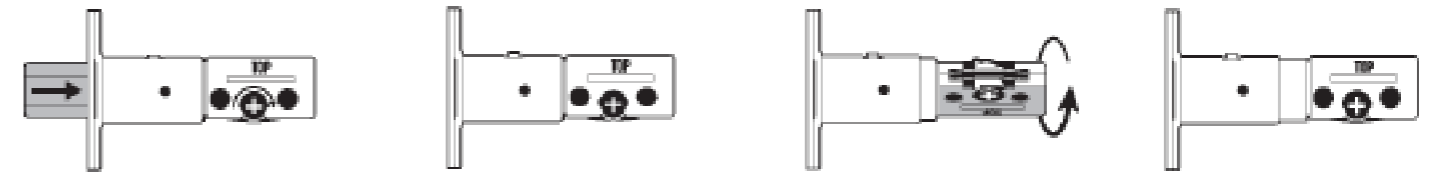





If required, the supplied deadbolt is adjustable from 60mm - 70mm depending on your backset.

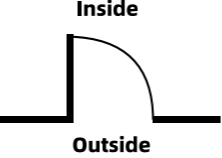

1. Retract deadbolt completely by rotating spindle cross thing
2. The shorter backset is 60mm
3. Twist the full assembly, the deadbolt will extend through the center
4. The extended backset is 70mm

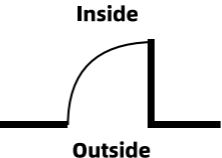
⚠ Confirm Opening Direction (handing)

Check if your door is a left or right hand opening door, you may need to make the below adjustments to suit.

	Inside	Outside	LEFT HAND OPENING	RIGHT HAND OPENING
				
				
			<p>Check the lock handing as pictured</p> <p>⚠ IMPORTANT Make sure the spindle is always kept horizontal. This may need to be trimmed to suit door thickness.</p>	<p>Make sure the Deadbolt is kept retracted during installation.</p> <p>⚠ IMPORTANT Change the L or R position switch inside the back panel.</p> <p>⚠ IMPORTANT Check the deadbolt knob position as indicated for left or right handed operation.</p>

Installation:

Step 1: Install deadbolt (see latch instructions included)

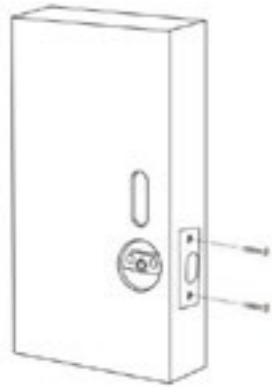

1. Mark and crop door using installation template provided
2. Ensure holes are clear of any sharp edges and clean of swarf and wood dust.
3. Ensure deadbolt is fitted with TOP upwards.

Step 2: Install Screw Posts & Rubber Boot



1. Measure door thickness and install appropriate length screw posts.
2. Attach rubber boot to front panel.

Step 3: Install front panel

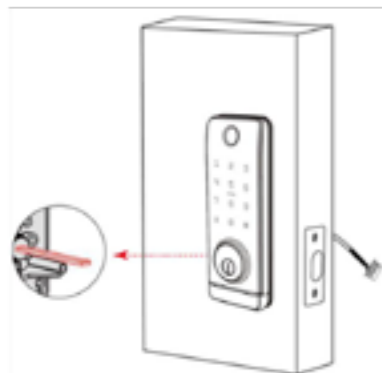

1. Feed power cable through door
2. Align spindle and posts to deadbolt latch and mount front panel to door.

⚠ IMPORTANT
Ensure spindle is horizontal and bolt is retracted.

Step 4: Install mounting plate

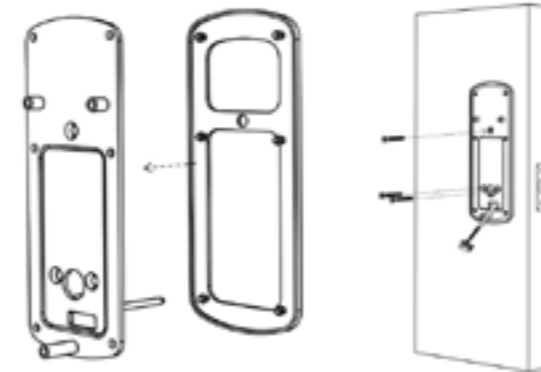

1. Attach rubber boot to mounting plate
2. Feed power cable through the mounting plate
3. Align the locating pins to the front panel and attach to door using mounting screws.

Step 5: Mount back panel and finish installation

⚠ IMPORTANT
Do not pull on the plug or cable with force or let the hardware hang from the cable, damaged caused will void the warranty



1. **⚠ IMPORTANT**
Plug in power cable ensuring the plug is around the correct way for the plug to accept its receiver correctly.
2. Push excess cable back through the mounting plate and align back panel onto mounting plate, securing with 3x 10mm machine screws.
3. Install the correct type of batteries into the lock (4 x Alkaline AA batteries)
4. Re attach battery cover plate
5. Finally fit striker plate and striker box to the door frame ensuring that the latch and bolts work freely when the door is closed.
6. To test the correct operation of the deadbolt of the lock test by turning the inside knob and ensuring it runs freely into the striker plate without any resistance. If binding occurs the striker plate might need a re adjustment in position.
7. Installation of the lock is now complete

Lock Installation Checklist

1. Holes drilled and aligned squarely as per drilling template.
2. Ensure bar on outer barrel is horizontal.
3. Ensure the rubber boot is aligned correctly with a good seal on the door, also making sure the lugs are correctly seated in their holes .
4. Ensure bolt is retracted when installing.
5. Ensure correct handing is set.
6. Ensure inner knob is correctly positioned.
7. Ensure all screws and bolts are correctly tightened.
8. Ensure power cable is installed and not bent or crimped in door.
9. Check batteries are Alkaline and installed correctly.
10. Check to see if the lock requires a software update via the TT App

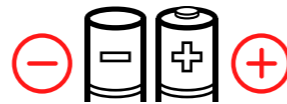

1. Date Installed: / /
2. Installed By:
3. Pin: #

Manual reset:

If you are not admin of the Smart Lock, remove battery cover and complete:

Long press the reset button beneath the battery case for 5 seconds or until you hear: "Please Input Initialisation Passcode".

Now input code "000#" on the keypad.

The system reset will be complete. From here you can re-link the SL37E Smart Lock to your phone via the TT App.

**Note: this will clear all previous users from the locks memory*



Using your Sylvan SL37E Smart Lock

Manually unlocking with Key

The SL37E Smart Lock has a mechanical key override to unlock it. The key location is on the front panel.

Insert one of the included keys, turn to unlock.

Maintenance Guide:

Maintenance should be carried out on your lock every 6 months:

- Check that the screws fixing the mortice Lock are tight.
Check that the screws fixing the rear panel to the front panel are tight.
- Check if batteries need replacing. If battery percentage is low replace with four fresh Alkaline 1.5V AA batteries.
- Wipe the surface of the Lock with a damp cloth, we recommend only water is used. This will help remove any dust or micro contaminants from the surface.
- It is also recommended to do a full factory reset of the Smart Lock to ensure software runs correctly.
- Check rubber boot to ensure the seal between lock and door is still good.
-

**Note: In settings on the app, the reset button can be switched on or off depending if you want this feature available to anyone with access to the inside panel.*

TTLock App Set-up instructions:

1. Download app

- Download the TTlock app onto your device
- Through Apple (IOS version) use app store to download TTlock
- Through Android version go through Google play (English version)

Otherwise use the below QR codes

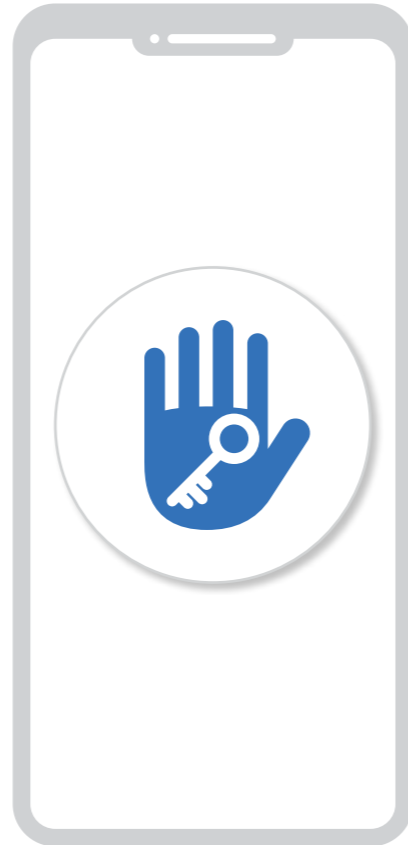
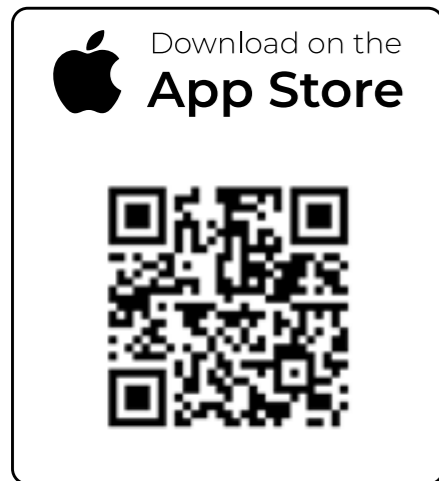

TTlock App

- TTlock supports multiple types of locks and devices
- TTlock currently supports 200 countries
- Verification codes will be sent to users' mobile phone or email depending on how you have registered above.

⚠ IMPORTANT

By default, this lock comes standard with Autolock 'off'. To lock from the outside, hold the # button down and deadbolt will lock.

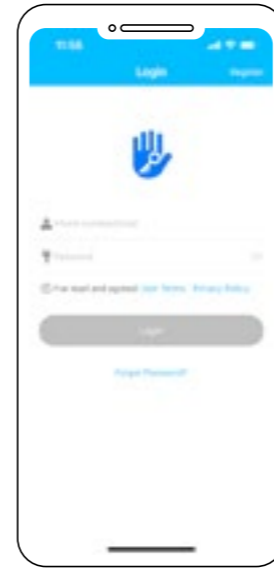

1. Register a new account (phone number or email) or login with an existing account if you already have one.



2. With App open touch on main screen + Add lock



3. While standing near the lock (and with the 4 good quality AA alkaline batteries installed into the lock) wake the lock up by touching the key pad.
4. Your lock will appear on the screen, then click +

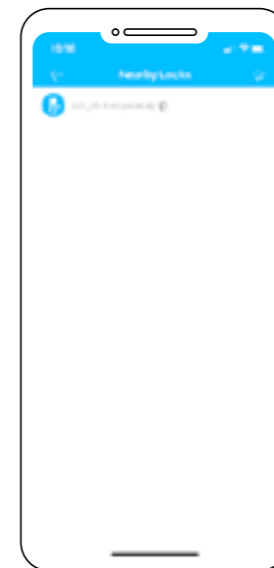

5. Rename the lock. e.g. home front door
6. The lock is now successfully added to the app.



7. If you have downloaded the app and loaded your lock on your device you are now the administrator of this lock, from here you can now add or delete users / passcodes / RFID card etc.

Management of app and lock

Bluetooth (lock and unlock)

- Make sure your phone has bluetooth and is switched on
- The app can be used to lock or unlock the door by using bluetooth within a 5m range.
- Note: the lock will automatically re lock itself depending on the setup of the auto lock function through the app.
- From the app push the (padlock) symbol to lock or unlock the device.
- Note: 5-meter Bluetooth range can vary depending on interference such as steel, thick walls and micro wave interference etc.

Setting a passcode:



- Passcodes are another way of unlocking the device
- This lock can accept up to 150 unique PIN codes.
- Careful consideration should be taken to ensure each PIN is set up in a way that they can be well managed at a later time. We suggest naming each PIN with the name of the person using it. E.g. Bobs PIN
- We suggest when setting up passcodes to do it via the custom setting to create your own pin number. It needs to be between 4-9 digits.
- Recurring PIN codes used to give access to the user of this code at certain time of day and week.
- You can also set up Pin codes for One timed and also timed access (for example a tradesperson working in your house for a short period of time).

RFID cards

- This lock comes with three RFID cards and can store up to 200 unique RFID cards.

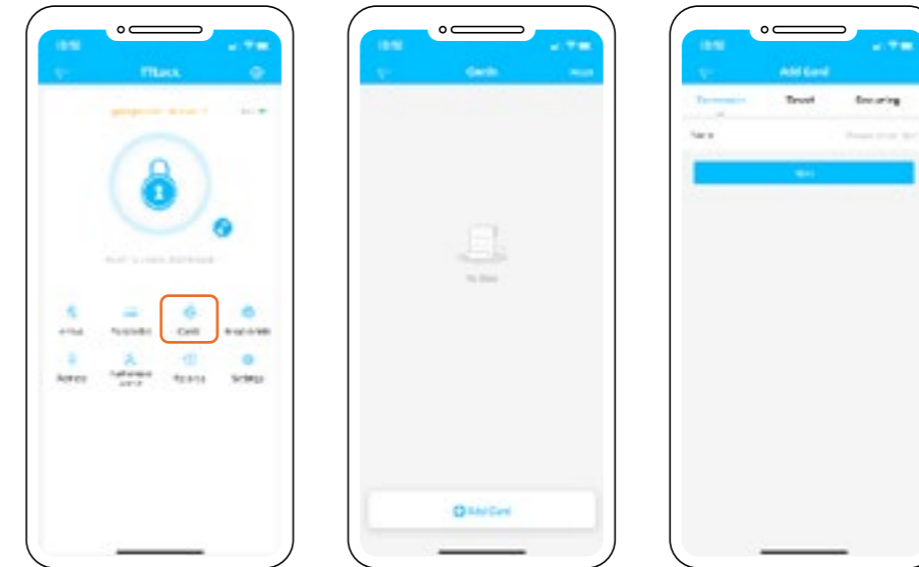

- To add these to the lock, touch RF Cards, then add card
- Decide if a Permanent or Timed or Recurring user
- Name the Card (we suggest the users name) e.g. Bobs RFID
- Then touch card against keypad to accept card to lock

Passage mode

- The TT app can be used to put the lock into passage mode. NB: Passage mode is where the lock can be opened without a passcode etc

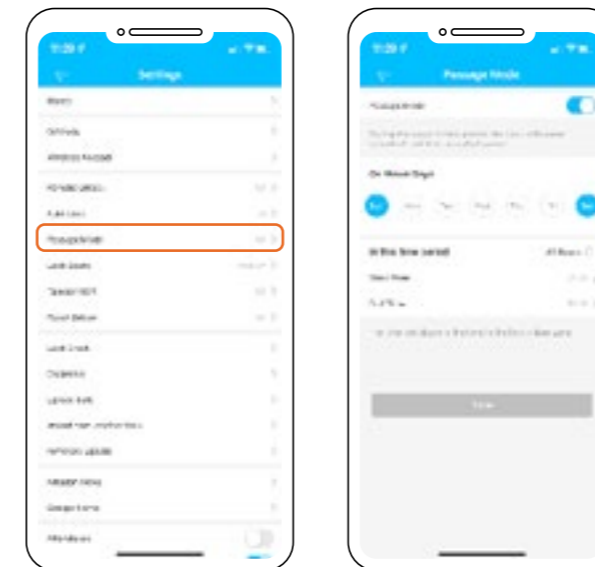

- Under the setting tab of the lock, you can switch passage mode on or off
- You can also set up a calendar so that the lock can go into passage mode on certain days at certain times.
- Note for security reasons the passage mode only starts once a successful entry to unlock the lock has been accepted.

To lock the door when in passage mode, press and hold the # key on the lock.

Finger Prints

- This lock can accept up to 200 Unique finger prints



- From main screen click on Finger print

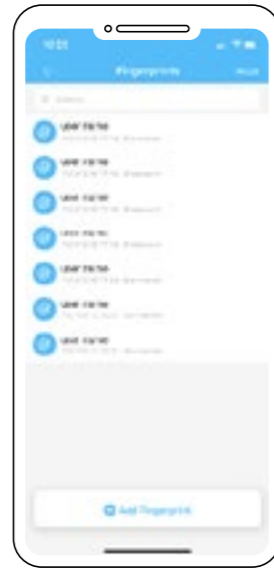

- Then add finger print
- Decide if a Permanent, Timed or Recurring user



- Name the finger print (we suggest the users name) eg Bobs Finger



- The app then prompts you to present your finger or thumb to the reader.
- Watch and listen to the prompt of the app and lock you will see the image



- You will be asked to do this a number of times until all parts of the image on the app turn from black to blue.



- We suggest for convenience and user speed to save your finger print in a number of different positions. EG Bobs 1 finger, Bobs 2 finger etc.

Remote unlock

- This can be done using a smart hub SLG02 (sold separately) see 'sylvan.co.nz/smart-hub-slg02/'

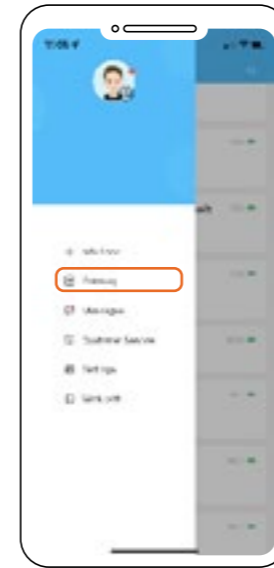

- Add the smart hub via the first screen of the TTlock app

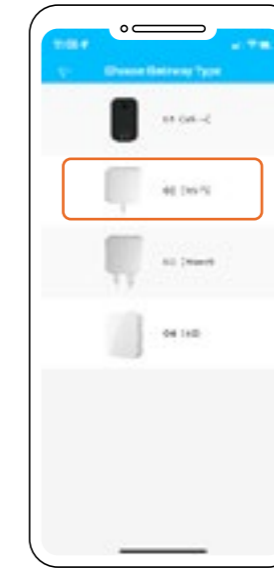

- Click on add Gateway
- Choose the G2 (Wi-Fi) option



- Connect power to the gateway and the indicator light will flash red, it's now in programming mode



- Click next
- Once seen it will ask for you to name the gateway e.g. (garage door gate way)

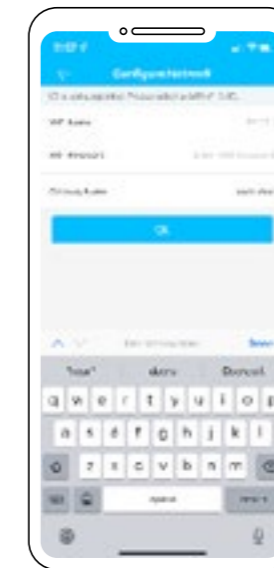

- It will also ask for your Wi-Fi password (Note this needs to be a 2.4G signal. 5G is not supported)
- Then the gateway is connected.



- Check that the gateway is online under the gateway link off the front page
- Ensure the gate way is within 10 meters of the lock

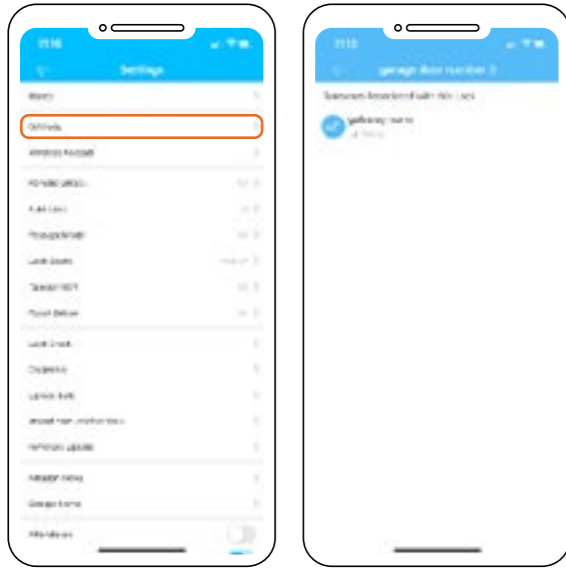

11. In the setting screen of the lock click on gateway and you should see your named gateway.

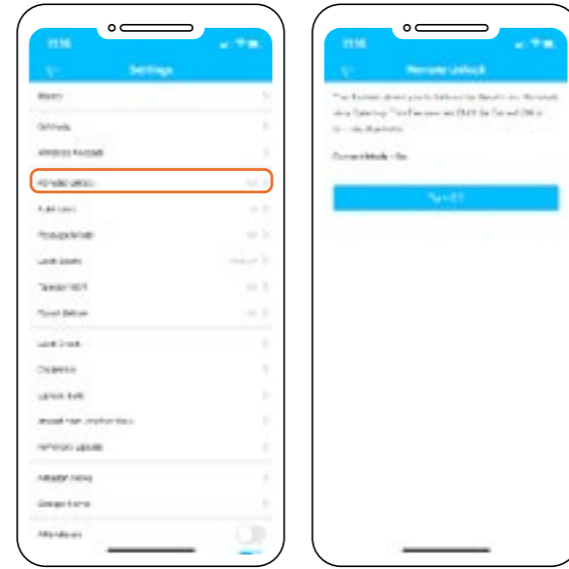

12. On the settings page select 'Turn on Remote Lock'.

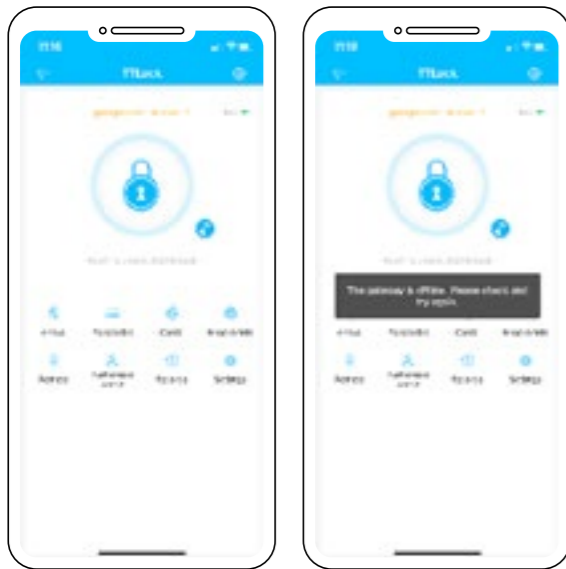

13. On the main programming screen of the lock a small Wi Fi symbol now appear next to the padlock symbol of the app.

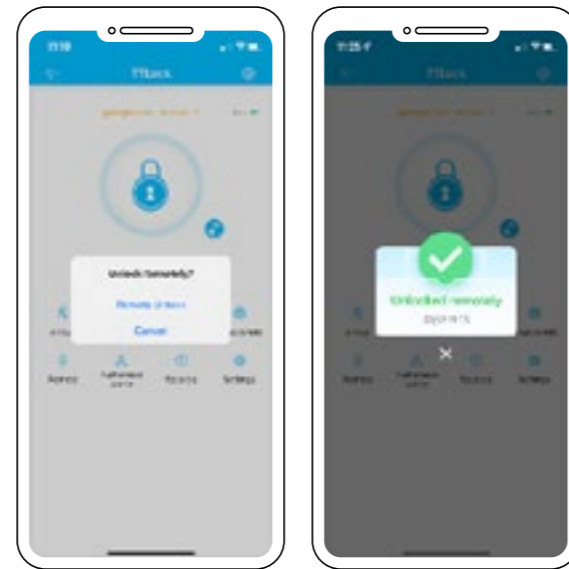

14. By clicking on the Wi Fi symbol, then clicking Remote unlock you will then be able to remotely unlock your lock from anywhere using the secure Wi Fi connection.

15. The app will show when the lock has been successfully unlocked.

Privacy Lock:

1. New feature with the SL37E is a privacy lock. To use it, enable in the lock settings and use button on underside of the inside panel of the Smart Lock as shown. Red means only the Key Override or Master Admin can enter, all other pincodes and RFID cards won't unlock the SL37E. By pushing the button once and holding, the lock goes into "secure lock is on" if pushed the second time, the lock goes into "secure lock is off"

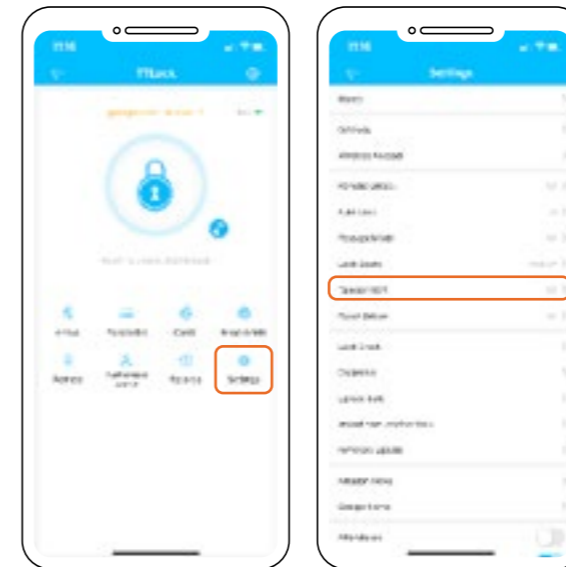
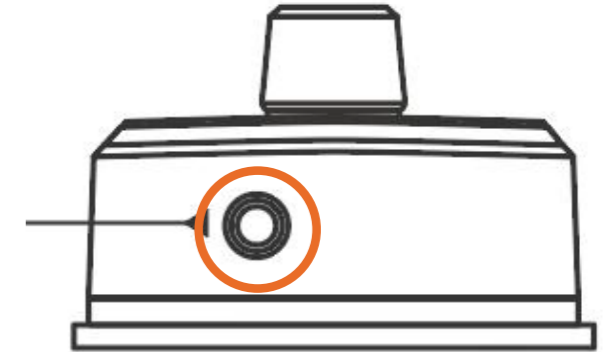

Note: Privacy can be switched on or off from the app. By switching the turn off feature, this will disable the button on your lock.

NOTES



PRODUCT WARRANTY

Customer Name: _____

Customer Phone: _____

Purchase Date: _____

Store name: _____

Receipt #: _____

Product Name: _____

Product Model: _____

Note: _____

Note:

1. Please keep this booklet and receipt so that you can use it when you need warranty service.
2. We provide you with a two-year warranty from the date of purchase.



127 Diana Drive
Glenfield
Auckland 0627
Ph: +64 9 444 5359
Email: sales@gdrutter.co.nz
Web: www.sylvan.co.nz