



Download the
Sylvan Smart App
Scan the QR Code to get started!

SL38E

INSTALLATION INSTRUCTIONS



2026 V1

Introduction

Thank you for choosing Sylvan, this lock is for Residential use only, and its two year warranty (mechanical and electronic) only applies for locks being used for residential use.

To ensure you get the best out of your purchase we ask that you follow the below:

- Please read these instructions fully before installation of this lock.
- We recommend this lock is installed by a professional installer or a serious DIYer to ensure correct installation and operation.
- The supplied rubber boots must be installed; however, this smart lock requires a smooth flat surface to hold its water tightness. This lock is not suitable for use on a tongue and groove door, where water can penetrate the lock via a groove in the door.
- We recommend that this lock is never fully exposed to direct weather for long periods of time. For long lasting properties of the product, positioning the lock under a eave or sheltered position is best.
- This lock is rated IP55, but only on the outward face of the lock. No warranty is given if the lock gets damaged from water for the inside of the door.
- This lock is not suitable for use on a gate.
- This lock comes with a mechanical key override, this can be used in a situation of complete battery loss. We recommend an override key is put somewhere safe outside in case complete power loss.
- Replace batteries when they are showing low voltage on the app.
- All batteries used with this lock must be high quality Alkaline (4 x AA batteries), to ensure long lasting use.
- Rechargeable batteries cannot be used with this lock.



sylvan
WARRANTY*

2 YEARS
MECHANICAL

2 YEARS
ELECTRONIC



Installation Video

Scan this code:



App Setup Video

Scan this code:



If you prefer not using an app for programming your smart lock, most functions can be setup manually using the instructions here:



Lock Dimensions:

Product specifications:

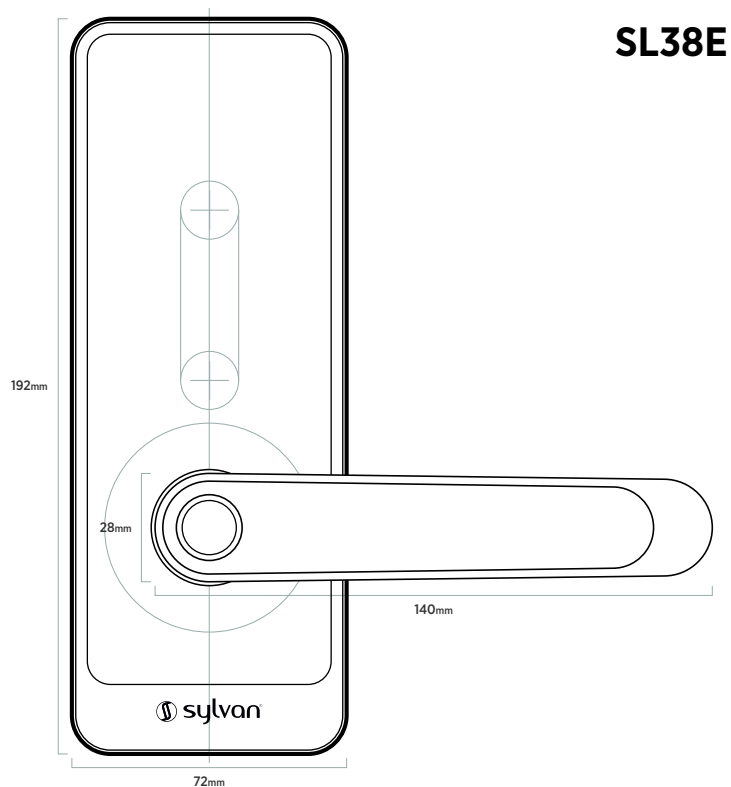















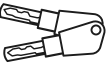

Model number	SL38E	Door thickness range	35mm - 60mm
Material of Manufacture	Aluminum alloy	IP rating	IP55
Weight	3 kg	Type of use	Residential use only
Options of unlocking	Blue tooth Finger print Passcode Card Mechanical key Gateway (optional) Disc (optional)	Passcode capacity	App unlocks infinite Fingerprints: 200 max Passcodes: 150 max RFID Cards: 200 max
Working temperature	-10 - + 55 degrees C	Working Humidity	0-95%
Normal voltage	6 volts (4 x Alkaline batteries)	Warranty	2 years mechanical 2 years electronic
Low voltage Alarm	Less than 4.8 Volts	Lock	Stainless steel body
Lever handing	Reversible	Latch bolt	Reversible

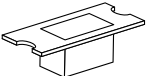

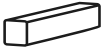
Anti Peeping Technology

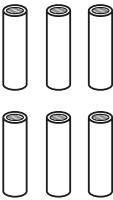
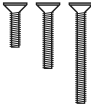
This lock offers anti-peeping virtual passcode entry by inputting a random passcode either before or after the proper passcode followed by the # key.

- 
 - **Front panel**
Qty x1
 - 
 - **Back panel**
Qty x1
 - 
 - **User manual**
Qty x1
 - 
 - **Installation template**
Qty x1
 - 
 - **Mortice lock / latch**
Qty x1
 - 
 - **Striker plate**
Qty x1
 - 
 - **RFID Tag**
Qty x2
 - 
 - **Self adhesive disc**
Qty x2
 - 
 - **Mechanical keys**
Qty x 2
 - 
 - **Waterproof rubber boot**
Qty x2
 - 
 - **Striker Plate Box**
Qty x1
-
- 
 - **Wood screws**
4x25mm - Qty x4
 - 
 - **Short spindle 60mm**
Qty x1 (for narrow doors 35mm or greater)
 - 
 - **Long Spindle 80mm**
Qty x1 (for wider doors 65mm or less)
 - 
 - **Connection posts**
Qty x3
(M4x30 - for 35-40mm Door thickness)
(M4x35 - for 40-60mm Door thickness)
 - 
 - **Various M5 machine screws**
Qty x3
(25mm, 30mm, 40mm)
 - 
 - **Smart hub**
Qty x1 (optional)

Check handing of the lever
Below are the instructions to change handing.

⚠ IMPORTANT
ONLY ROTATE THE HANDLE UPWARDS IN THE DIRECTION SHOWN BELOW - DAMAGE CAUSED WILL VOID WARRANTY

Front (outside) Panel

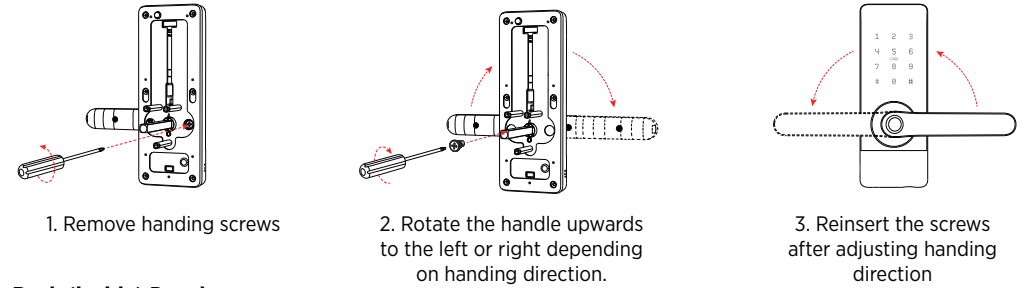

Back (inside) Panel

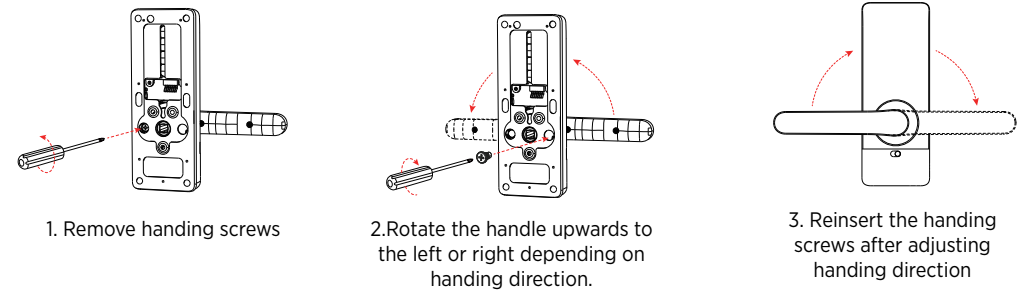

Step 1: Install Latch (see latch instructions included)

1. Mark and crop door using installation template provided
2. Ensure holes are clear of any sharp edges and clean of swarf and wood dust.
3. Adjust tongue of latch depending on the way the door operates (refer to page 6)

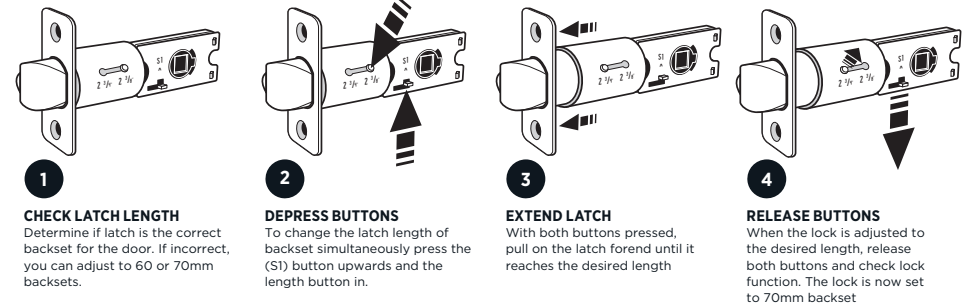
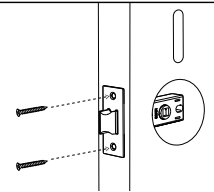

⚠ CRITICAL WARNING: POWER CABLE MANAGEMENT

The power cable is the most delicate part of your lock. Do not pinch, crimp, or crush the cable during installation. Ensure it sits in a clear “pocket” within the door cavity.

Note: Any damage to the cable caused by improper handling during installation will void your warranty.

Step 2: Install Outside Lock Panel

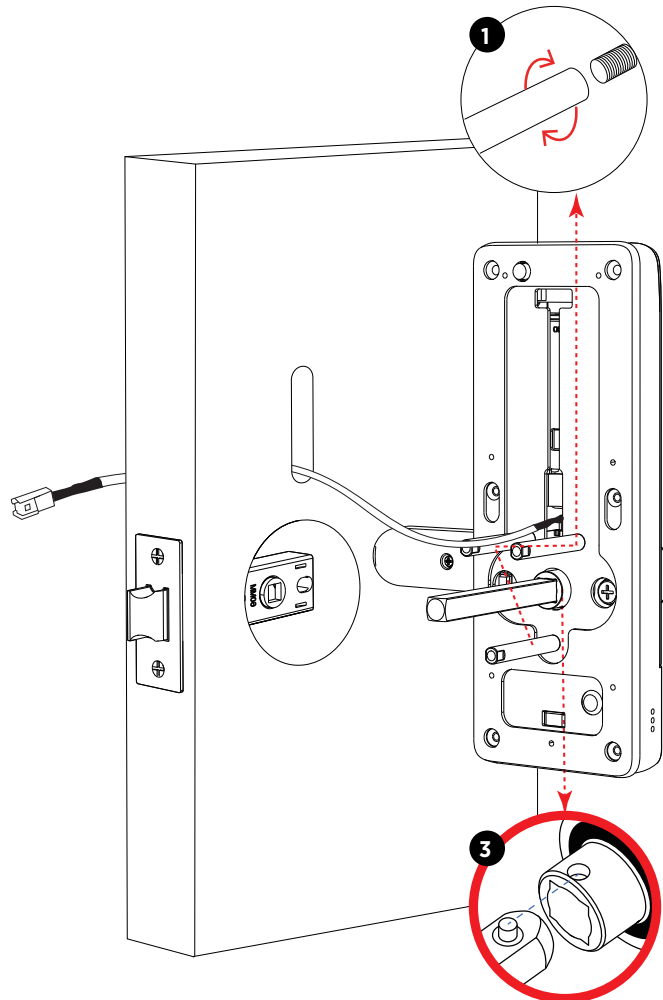

- 1. Attach Connecting Posts**
 Fit the three connecting posts to the threaded stubs, as shown in the diagram. Use the correct length of connecting posts according to the door thickness: For 35-40mm thick doors, use the short posts. For 40-60mm thick doors, use the long posts.
- 2. Select Spindle:** Choose the correct length based on your door thickness:
35mm – 48mm door: Use the 60mm spindle.
48mm – 65mm door: Use the 80mm spindle.
- 3. Secure Spindle:**
 Clip the spindle into the assembly.
- 4. Install Rubber Boots**
 Place the rubber boots on both the outside and inside units. Ensure each rubber boot aligns correctly with the receiving holes on the back of the panel, as they only fit one way.
- 5. Feed Outside Panel:**
 - Feed the outside panel into the door's mounted mortice lock, aligning the spindle and posts through the lock and pre-drilled holes in the door.

⚠ IMPORTANT: When feeding the power cable through the door, ensure adequate space to prevent the cable from being crushed, damaged, or cut during installation.

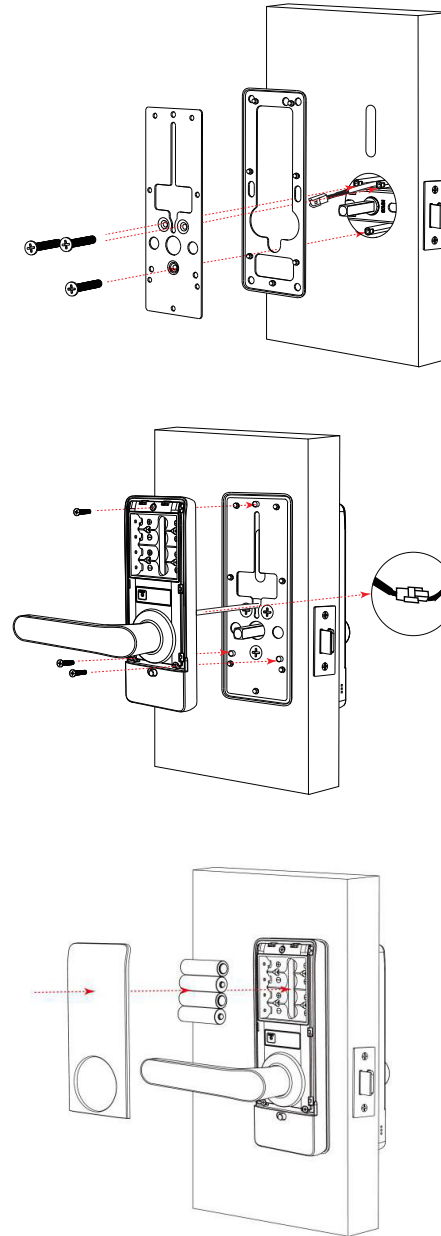

Step 3: Install Inside Lock Panel

- 1. Position and Secure the Rubber Boot Mounting Plate**
 Align the rubber boot mounting plate to the exterior face of the door.
- 2. Fit Fixing Screws**
 Use the correct length fixing screws to lightly secure the lock to the door.
- 3. Connect Cable:** Remove the battery cover. Carefully plug the power cable into the receiver.

Tip: The plug only fits one way—don't force it!
- 4. Manage Excess Cable:** Tuck any extra cable length back into the door cavity to prevent it from being pinched between the panel and the door.

⚠ IMPORTANT
 Pinching, crimping or crushing the power cable may break the internal connection, and void the lock warranty.
- 5. Check Rubber Boot Position**
 Ensure the rubber boots are laying flat against the door.
- 6. Tighten the Lock**
 Hand-tighten the lock firmly against the door face.
- 7. Insert Batteries**
 Install 4 AA alkaline batteries into the lock. We recommend Energizer Max Plus
- 8. Replace Battery Cover**
 Reattach the battery cover plate.
- 9. Install Striker Plate and Box**
 Attach the striker plate and striker box to the door frame, ensuring that the latch and bolts operate smoothly when the door is closed.
- 10. Test Deadbolt Operation**
 Test the latch by lifting the inside handle to ensure it fits freely into the striker plate without resistance. If there is binding, adjust the striker plate position as needed, by bending the adjustable tongue.
- 11. Completion**
 The lock installation is now complete.

Lock Installation Checklist

1. Holes drilled and aligned as per drilling template.
2. Ensure the rubber boot is aligned correctly with a good seal on the door, also making sure the lugs are correctly seated in their holes .
3. Ensure all screws and bolts are correctly tightened.
4. Ensure power cable is installed and not bent or crimped in door.
5. Check batteries are Alkaline and installed correctly.
6. Check to see if the lock requires a software update via the TT App



1. Date Installed: ____ / ____ / ____
2. Installed By: _____
3. Pin: # _____

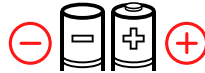

Manual reset:

If you are not admin of the Smart Lock, remove battery cover and complete:

Insert a thin object, like a paperclip, long press the reset button beneath the battery case for 5 seconds or until you hear: "Please Input Initialisation Passcode".

Now input code "000#" on the keypad.

The system reset will be complete. From here you can re-link the SL38E Smart Lock to your phone via the TT App.

**Note: this will clear all previous users from the locks memory*

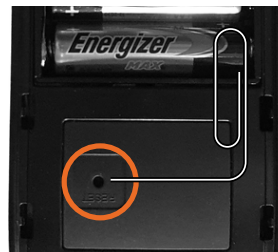

Using your Sylvan SL38E Smart Lock

Manually unlocking with Key

The SL38E Smart Lock has a mechanical key override to unlock it. The lock location is under the front panel.

Insert one of the included keys, turn and pull handle down to unlock.

Shown is the location of the mechanical key barrel, The Micro USB port beside it can be used to power up the Smart Lock if the batteries fail. When connected to a power bank or battery source, the Smart Lock can be powered up and then a PIN Code, RFID Card or the app can be used to unlock it.



Maintenance Guide:

Maintenance should be carried out on your lock every 6 months:

- If the accuracy of the fingerprint reader decreases, please replace batteries.
- Check that the screws fixing the mortice Lock are tight. Check that the screws fixing the rear panel to the front panel are tight.
- Check if batteries need replacing. If battery percentage is low replace with four fresh Alkaline 1.5V AA batteries.
- Wipe the surface of the Lock with a damp cloth, we recommend only water is used. This will help remove any dust or micro contaminants from the surface.
- It is also recommended to do a full factory reset of the Smart Lock to ensure software runs correctly.
- Check rubber boot to ensure the seal between lock and door is still good.

**Note: In settings on the app, the reset button can be switched on or off depending if you want this feature available to anyone with access to the inside panel.*



Smart Hub*

**UNLOCK
YOUR DOOR
ANYWHERE****



*sold separately **depending on structure and signal interference.

Sylvan Smart App Set-up instructions:

1. Download the Sylvan Smart App

Apple (IOS version) use app store to download Sylvan Smart

Android version go through Google Play to download Sylvan Smart

Or alternatively scan the QR Code below



Sylvan Smart App

- Sylvan Smart supports multiple types of locks and devices
- Verification codes will be sent to users' mobile phone or email depending on how you have registered above.

Account setup and add locks

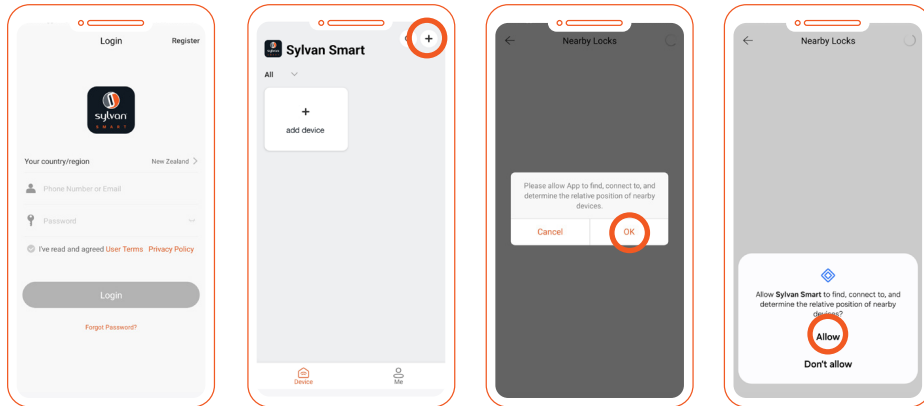

1. Register a new account (phone number or email) OR if you have an existing account login using your current account details
2. With App open touch on home screen select + / Add lock
3. While standing near the lock (and with the 4 good quality AA alkaline batteries installed into the lock) wake the lock up by touching the keypad.

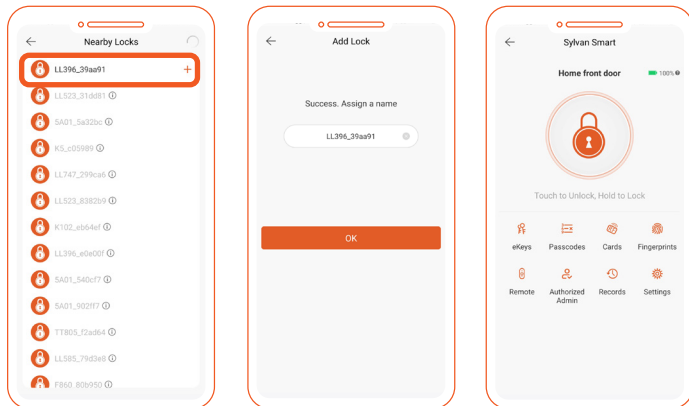

4. Your lock will appear on the screen, then select +
5. Rename the lock. e.g. home front door
6. The lock is now successfully added to the Sylvan Smart app.

Bluetooth (lock and unlock)

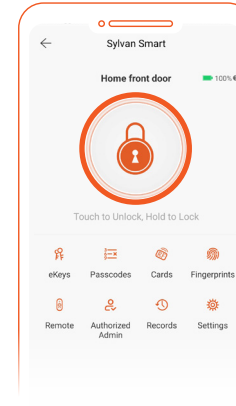

1. Make sure your phone has Bluetooth and Bluetooth is switched on.
2. The app can be used to lock or unlock the door by using Bluetooth within a 5m range.
3. From the app press the (padlock) symbol to lock or unlock the device.

NOTE

- The lock will automatically re lock itself depending on the setup of the auto lock function through the app.
- 5-meter Bluetooth range can vary depending on interference such as steel, thick walls and microwave interference etc.

RFID cards

This lock comes with three RFID cards and can store up to 200 unique RFID cards.

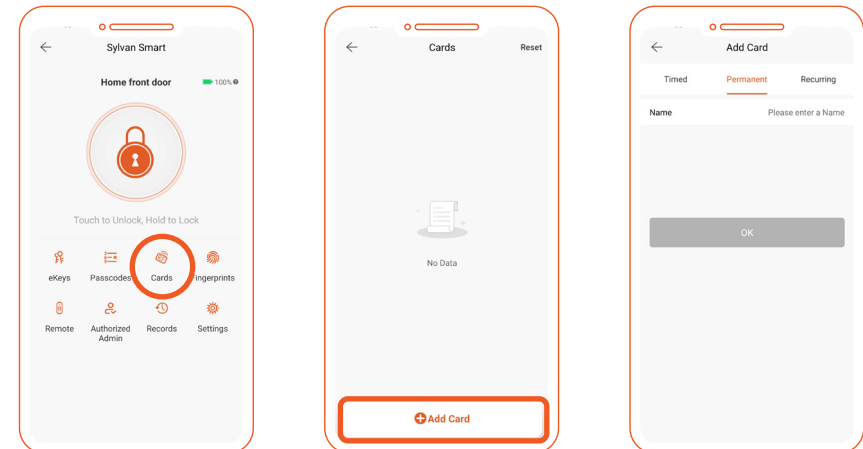

1. To add these to the lock, select Cards
2. Add card
2. Select Permanent, Timed or Recurring user
3. Name the Card (we suggest the users name) e.g. Bobs RFID, press ok.
4. Then touch card against lock keypad to accept card to lock

3. Management of app and lock

Setting a passcode:

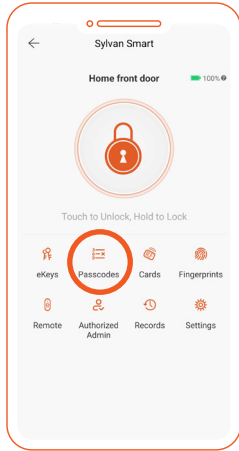

1. Open the Sylvan Smart App
2. Select your lock
3. Press Passcodes

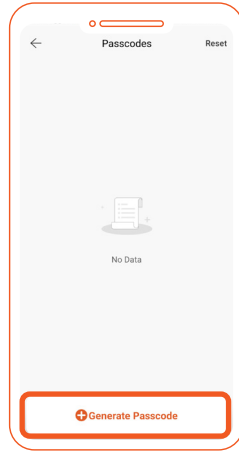

4. Generate Passcode

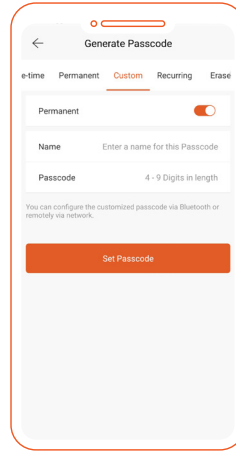

5. As suggested in the notes below Press "custom"
6. Ensure Permanent is switched for all time access
7. Enter a name for the passcode eg Bob's code
8. Enter the 4–9-digit passcode then # or ✓ depending on the model (refer above)
9. Press Set passcode

Helpful hints when setting up passcodes:

- Careful consideration should be taken to ensure each PIN is set up in a way that they can be managed later. We suggest naming each PIN with the name of the person using it. E.g. Bobs PIN
- When setting up passcodes use the 'custom' setting to create your own pin number. It needs to be between 4-9 digits followed by '#' or '✓' e.g. 1234#.
- Recurring PIN codes are used to give access to the user of this code at certain times of the day and week.
- Codes can also be created for "One time" access (for example a tradesperson working in your house for a short period of time).

Fingerprint Access: (only applicable if your lock has this feature)

This lock can accept up to 200 Unique fingerprints

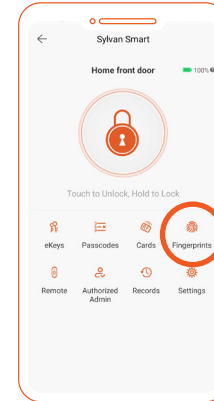

1. From your locks main screen select Fingerprints

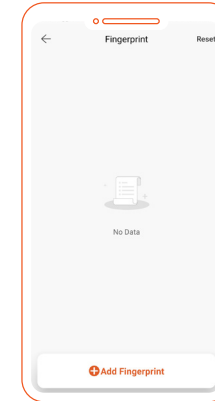

2. Then add fingerprint

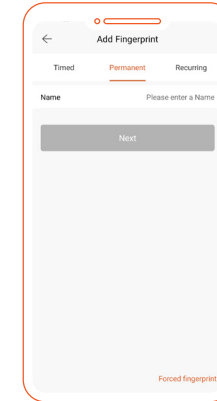

3. Decide if a Permanent, Timed or Recurring user
4. Name the fingerprint (we suggest the users name) eg Bobs Finger

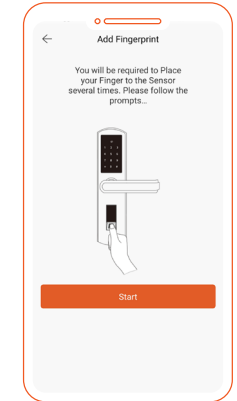

5. The app then prompts you to present your finger or thumb to the reader.

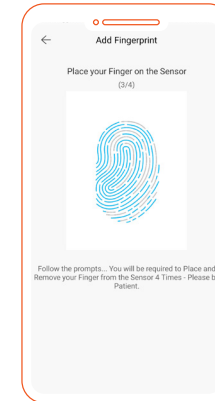
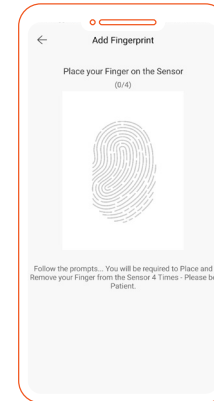

6. Watch and listen to the prompt of the app and lock you will see the image of the fingerprint and be asked to present your finger to the reader.
7. You will be asked to do this several times until all parts of the image on the app turn from black to orange.

Note:

We suggest for convenience and user speed to save your fingerprint in several different positions. EG Bobs 1 finger, Bobs 2 finger etc.

3. Management of app and lock

Passage mode

The Sylvan Smart app can be used to put the lock into passage mode.

Note: Passage mode is where the lock can be opened without requiring the passcode to be entered.

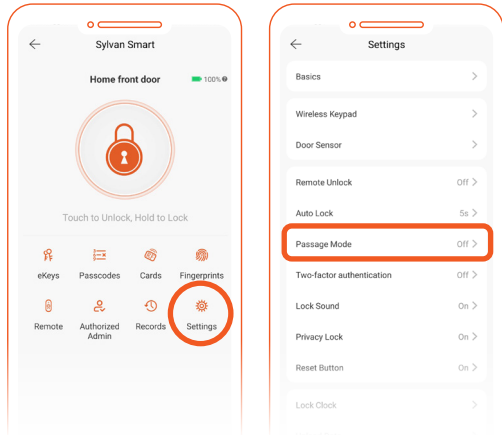

1. Under the setting tab of the lock, you can switch passage mode on or off
2. You can also set up a calendar so that the lock can go into passage mode on certain days at certain times.
3. Note for security reasons the passage mode only starts once a successful entry to unlock the lock has been accepted.

To lock the door when in passage mode, press and hold the # key on the lock.

Enable Manual Passage Mode

You can enable Passage Mode manually by unlocking the Sylvan Smart using a PIN or another valid method, then entering 123# or ✓ on the keypad.

Lock the Door While in Passage Mode

- **Option 1:** Open the Sylvan Smart App, then press and hold the Lock button. Lift the handle to engage the deadbolt.
- **Option 2:** To exit Passage Mode from the keypad, press and hold the # or ✓ key, then lift the handle to engage the bolt.

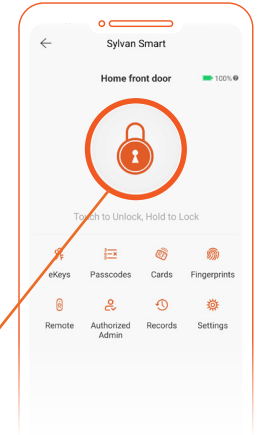

Scheduled Passage Mode

Scheduled Passage Mode keeps the lock unlocked during the times you specify.

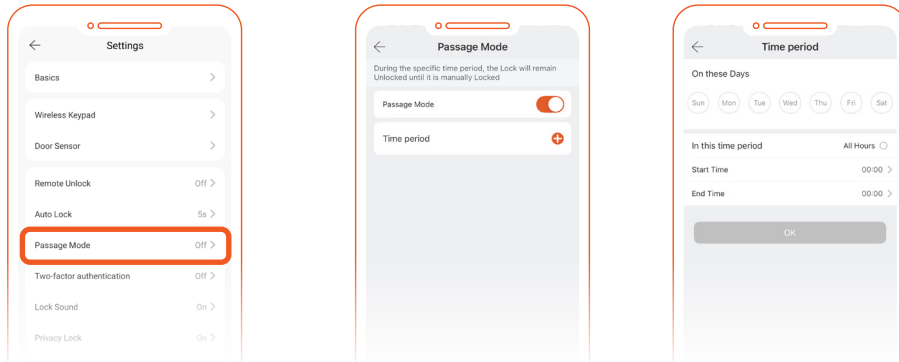

- Go to Settings > Passage Mode.
- Choose the days and hours you want the lock to remain open, for example Monday to Friday, 9:00 to 17:00.
- When unlocked electronically during these hours, the lock will remain in the unlocked state.
- If Auto Lock is enabled, the lock will secure itself again at the scheduled time.

Privacy mode

Some Sylvan locks have a secure lock function (SL37, SL39) the button is underneath (SL38, SL40, SL41) the button is on the back face of the lock.

When the secure lock feature is turned on (Red is showing on the SL38/SL40/SL41) only the key override or master admin code can be used to unlock the lock. If this function is turned off (showing Green) the lock is in normal mode.

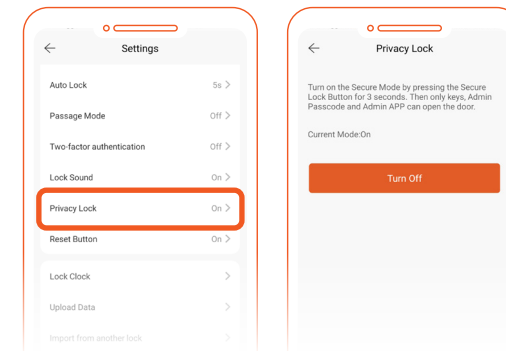

1. Under the setting tab of the lock, you can switch privacy mode on or off, By switching the turn off feature, this will disable the button on your lock.

3. Management of app and lock



Remote unlock

This can be done using a smart hub SLG02 (sold separately) see www.sylvan.co.nz/smart-hub-slg02

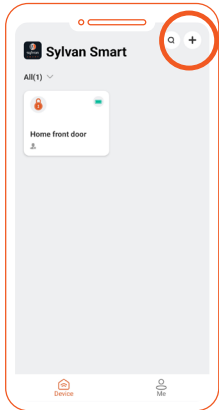

1. Add the smart hub via the home screen of the app
2. Ensure the gateway is within 10 meters of the lock and unplugged
3. Click on + / add new device

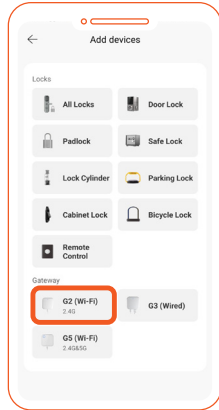

4. Choose the G2 (Wi-Fi) option under Gateway

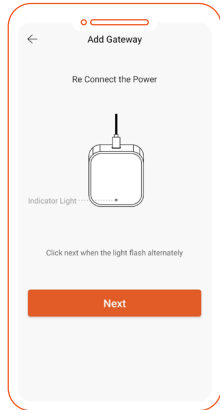

5. Connect power to the gateway and the indicator light will flash red, it's now in programming mode
6. Click next

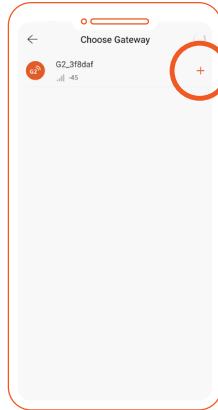

7. Your gateway will appear on the screen, then select +

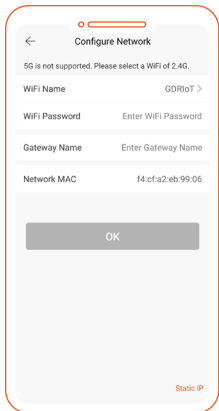

7. **Configure network:**
The app will ask you to select your WiFi network and password (**Important this needs to be a 2.4G** signal. 5G is not supported).

Ensure your smart phone is connected to the 2.4G signal whilst connecting to the gateway

Once seen it will ask for you to name the gateway e.g. (garage door gate way)

Once complete, select OK

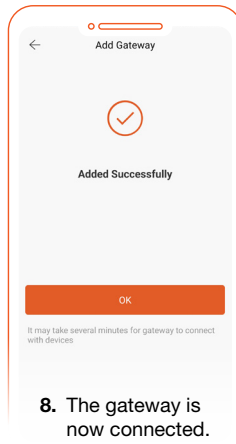

8. The gateway is now connected.

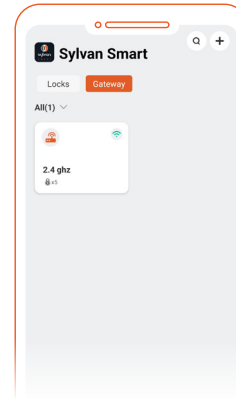

9. Check that the gateway is online under the gateway link on the front page of the App

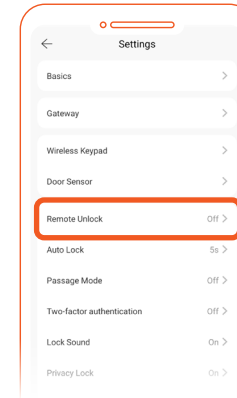

10. Return to the setting screen of your lock and click on gateway and you should see your named gateway.

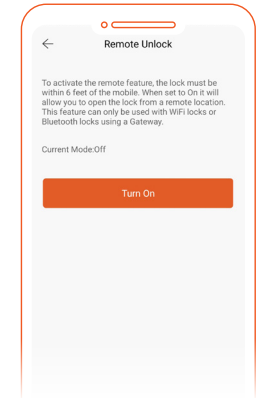

11. On the settings page select 'Turn On'

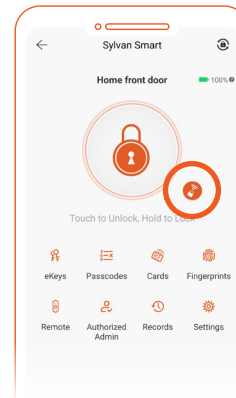

12. On the main programming screen of the lock a small WiFi/Padlock symbol will now appear next to the padlock symbol of the app.

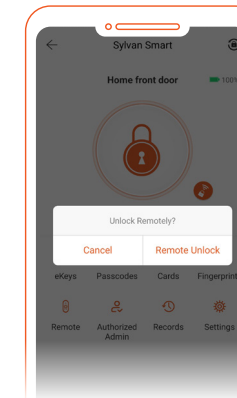

13. By clicking on the WiFi/Padlock symbol, then clicking Remote unlock you will be able to remotely unlock your lock from anywhere using the secure Wi Fi connection.

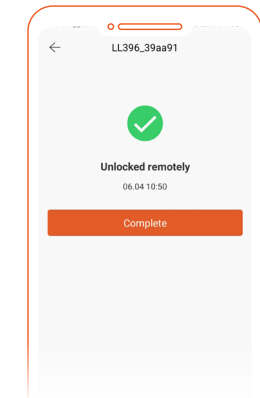

14. The app will show when the lock has been successfully unlocked.

Power and Time Settings

Check Battery Percentage

Use the Sylvan Smart App to check the battery level of your Sylvan Smart lock.

- On the lock selection page, the app shows an overview rounded to the nearest 5%.
- For a more precise reading, go to **Settings > Basics**.
- To refresh the reading, select **Battery** and then **Update** while you are within Bluetooth range of the lock.

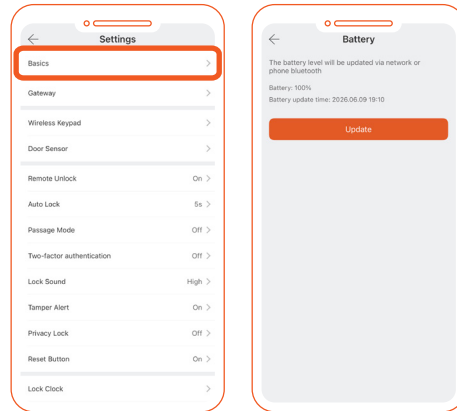

Calibrate the Lockset Clock

- Open **Settings > Lock Clock**.
- Select Calibrate Time.
- Your Sylvan Smart lock will sync with the app and set the correct time.
- This helps keep operating schedules and unlock records accurate.

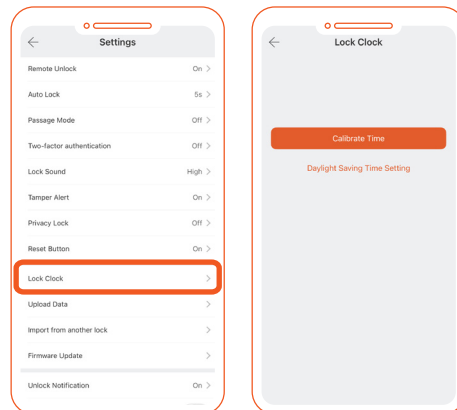

Authorised Admin

An Authorised Admin can access your Sylvan Smart using their own Sylvan Smart App.

- They can add, change, or delete unlock codes that they create themselves.
- To set this up, go to **Authorised Admin** on the lock management home page, then select **Create Admin**.
- Send the invitation to the phone number or email address linked to the recipient's Sylvan Smart App account.

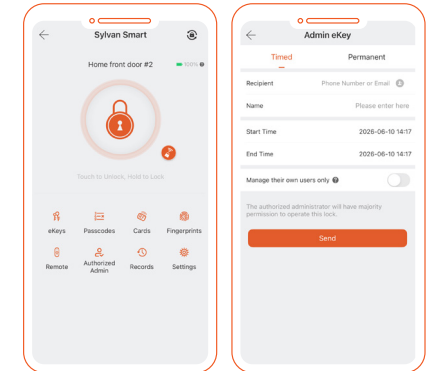

e-Key Management

An e-Key allows another person to lock or unlock your Sylvan Smart lock through the Sylvan Smart App.

- e-Keys can be permanent or set with specific time or access parameters.
- On the lock management page, select **e Keys**, then choose **Send e Key**.
- Send the e-Key to the phone number or email address linked to the recipient's Sylvan Smart App account.

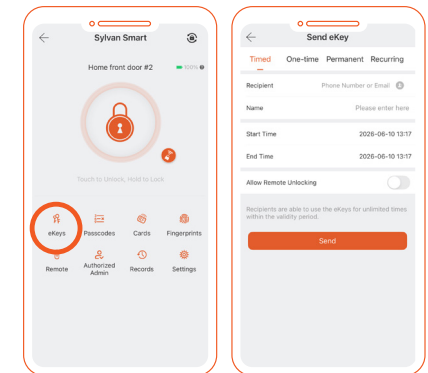

Transfer Ownership

The **Master Admin** can transfer ownership of a lock to another Sylvan Smart App account holder, including saved settings and PINs.

- Open the app menu, then go to **Settings > Transfer Lock**.
- Select the lock you want to transfer.
- Enter the recipient's phone number or email address associated with their Sylvan Smart App account, then select **Next**.

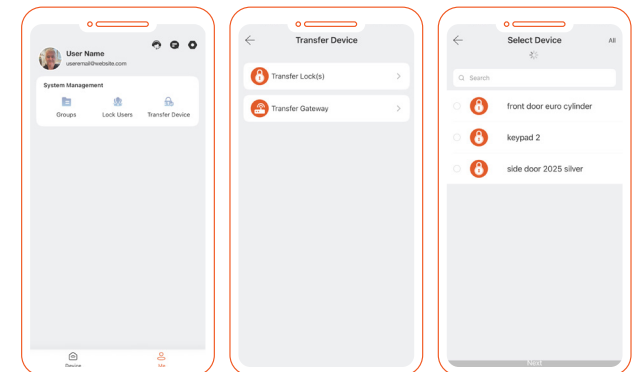

4. Additional Settings

Security and Access Records

Admin Passcode

Each Sylvan Smart lock comes with an admin passcode.

- To view it, go to **Settings** on the lock management page, then select **Basics > Admin Passcode**.

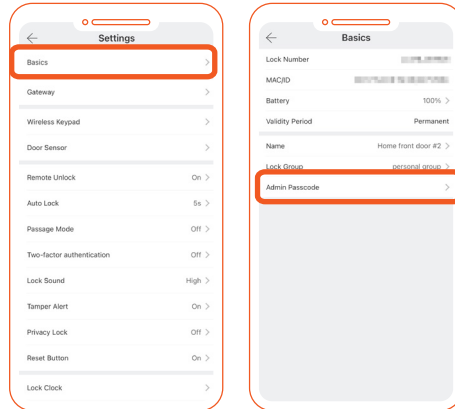

Lock Behaviour and Sound

Auto Lock

Auto Lock automatically disengages the exterior handle after a set period.

- In the app, go to **Settings > Auto Lock**.
- Adjust the timer or turn the feature off as needed.
- If Auto Lock is turned off, Passage Mode will not relock automatically.

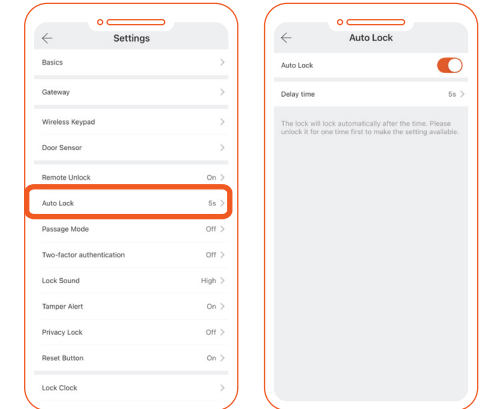

Unlock Records

The Sylvan Smart App records which passcodes were used to lock or unlock the Sylvan Smart and when they were used.

- To view these records, open the **Records** menu on the lock management page.
- Only a limited period of records can be stored in the app.
- You can export records to a spreadsheet for long-term storage, then clear or refresh the app records to keep them current.

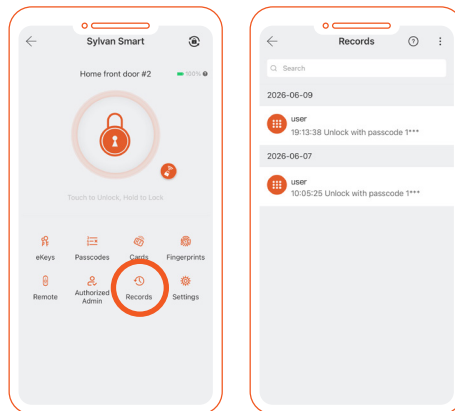

Lock Sound

Use Lock Sound to enable or disable audio feedback and to control the volume.

- By default, Lock Sound is enabled and set to high.
- Go to **Settings > Lock Sound** to change the setting.

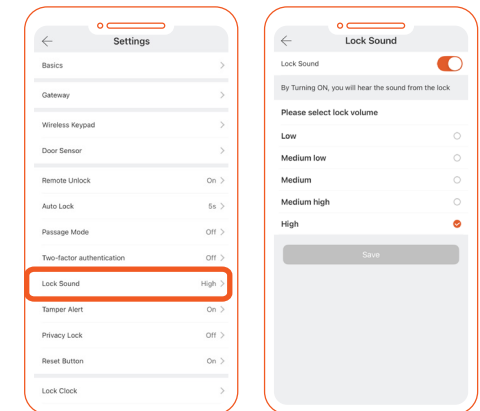

4. Additional Settings

Lock Sync and Grouping

Import from Another Lock

This feature lets you sync PIN codes and RFID cards between Sylvan Smart locks.

- Go to **Settings** > **Import from another lock**.
- Select the lock you want to import from.

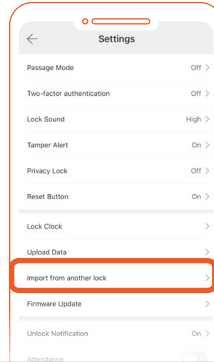

Lock Groups

Lock Groups let you organise multiple Sylvan Smart locks together, such as locks at the same site.

- First create a lock group in the main settings.
- Then, in each individual lock, go to **Settings** > **Basics** > **Lock Group** and assign the lock to the group.
- You can view lock groups from the lock selection page to keep the app home screen tidy.

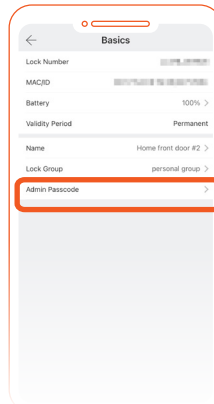
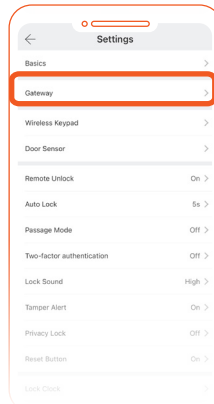

Reset Button Control

You can disable the manual reset button by turning off Reset Button in the Sylvan Smart App settings.

- Go to **Settings** > **Reset Button** and adjust the setting to suit your needs.
- This can be especially useful for Airbnb properties, rentals, or other shared-use installations.
- When the reset button is disabled, only the **Master Admin** can factory reset the lock.

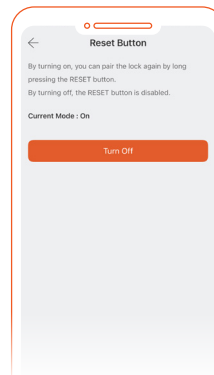
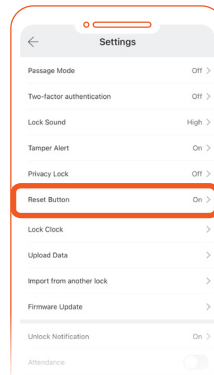

Factory Reset

- Via the Sylvan Smart App (Master Admin only): On the lock management page and within Bluetooth range, go to **Settings** > **Delete**, then enter your app password. The lock will then be factory reset.
- **Manual reset:** Remove the battery cover and hold the reset button in the battery compartment until you hear, “Please input initialization passcode.” Enter 000# on the keypad. The lock will then announce, “Deleting administrator successful.”
- If the **Reset Button** feature has been disabled, manual reset will not be available.

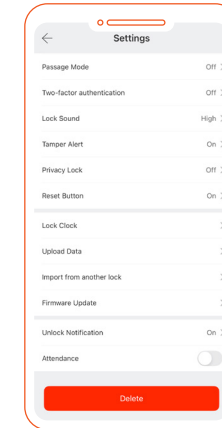

Remove Reset or Replaced Locks from the App

- To remove a reset or replaced lock from the Sylvan Smart App, open the app menu and go to **Settings**. Select **Transfer Lock(s)**, choose the lock, select **Next**, then choose **Remove the damaged device** at the bottom of the page.

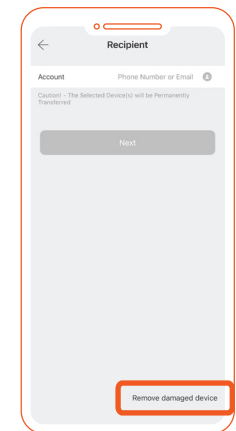
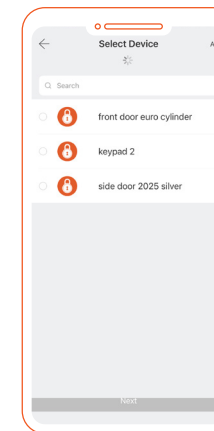
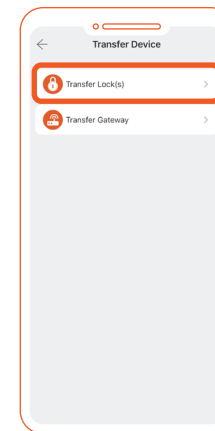
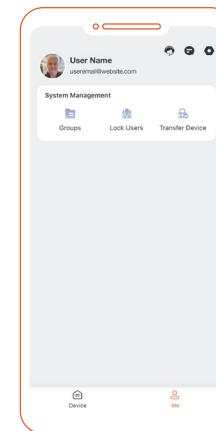



PRODUCT WARRANTY

Customer Name: _____

Customer Phone: _____

Purchase Date: _____

Store name: _____

Receipt #: _____

Product Name: _____

Product Model: _____

Note: _____

Note:

1. Please keep this card so that you can use it when you need warranty service.
2. We provide you with a two-year warranty from the date of purchase.

GDRutter
LIMITED

127 Diana Drive
Glenfield
Auckland 0627
Ph: +64 9 444 5359
Email: sales@gdrutter.co.nz
Web: www.sylvan.co.nz